



Canal &
River Trust

Making life better by water

The Boater's Handbook

Basic Boathandling and Safety for
Powered Boats and Unpowered Craft



If you have received this book from a hire boat operator, **please return it after your holiday so it can be used again.**



In partnership with



Environment
Agency

Charity no. 1146792

Safety Checklist

Avoid slips and trips!

- Watch out for mooring ropes, bollards, holes and other hazards.
- Use grab rails.
- Wear non-slip shoes.
- Don't try to jump from the boat onto the bank.
- Wear a life jacket.

Don't get crushed!

- A moving boat has the force to crush you – keep your body out of the way.
- Don't fend off with your arms, legs or a boat pole – let the fender take the impact.
- Don't have your legs dangling over the side, your hands over the edge or your head out of the hatch.
- Keep off the roof when underway (low bridges could knock you off the boat or worse).

Watch out for fire and fumes!

- The bottled gas used for cookers, fridges and heaters is heavier than air and, if there's a leak, it will lie in the bottom of the boat where it only takes a spark to ignite.
- Watch out for fumes from cookers, cabin heaters and water heaters or from engine exhaust building up in the boat. Carbon monoxide poisoning is extremely dangerous – early signs include headaches, tiredness, sickness and dizziness, and other flu-like symptoms. Anyone affected should get medical help right away.
- Switch off appliances when you're not using them.
- Keep ventilators open and free of obstructions.
- If you smell exhaust, gas, or petrol fumes, raise the alert right away.

Don't rock the boat!

- Think carefully before climbing onto the cabin roof as the boat could become top heavy and unstable.
- Don't all stand together on the same side if it risks tipping the boat over.

Preface

This booklet is the result of a detailed study of safe boating.

The research was carried out by the Canal & River Trust and the Environment Agency, with help from British Marine and the Trust's Navigation Advisory Group which is made up of experienced boaters. As well as introducing the basics of boathandling, it aims to help people spot risks and avoid accidents.

Feel free to copy it. All we ask is that you don't alter our messages, pictograms or illustrations.

We've tried to make the information in the handbook applicable to inland waterways generally, but local conditions vary, especially on tidal waterways. So always seek local information if you're planning to visit an area that's new to you.

We want the information in the handbook to reach everyone who goes boating on the inland waterways in a powered boat or unpowered craft.

A pdf version is downloadable from www.canalrivertrust.org.uk/safeboating

Contents

	Introduction	
	Who's in charge?	5
	Before setting off – top tips	6
1	Boathandling	
	Setting off	8
	Under way	9
	Steering	10
	Going aground, Slowing down and stopping	11
	Mooring	12
	Tying up	14
	Locks	16
	Bridges	30
	Winter cruising	32
	Wide beam boats, Powered & Unpowered Craft	33
	Tunnels	34
	Unpowered craft in tunnels	35
2	Boating Safety	
	Accidents, Falls	36
	Fire, explosion and fumes	38
	Collisions	42
	Crushing	43
	Capsize, Man overboard	44
	Operating injuries	46
	Lock safety	47
	Fast-flowing water	48
	Strong stream conditions	49
	Vandalism and aggression,	
	Waterborne diseases	52
	Training and guidance	53
	Carbon Monoxide	54
	Unpowered craft	55
	Stand up paddle boards (SUPBs)	56
3	Rules of the Waterway	
	Channel markers, Weirs, Overtaking,	
	Giving way, Speed limits,	57
	Passing dredgers or works,	
	Sound signals, Navigation lights	58
4	Good Boating Behaviour	
	Water sport zones	59
	Caring for the environment	60
	What makes a good boater?	62
5	Further Information	
	Contacts	64
	Useful information, Signs	68
	Signs	69

Welcome to The Boater's Handbook

This handbook gives you all the boating basics – the essential knowledge and techniques you need to make sure you enjoy yourselves and stay safe. Reading it before setting off will help you to spot the risks and take simple action to avoid problems. If you do run into difficulties, this understanding should help you get out of trouble quickly and safely.

1 Boathandling

Part one takes you through the basic skills for handling your boat.

2 Boating Safety

Part two gives important safety rules to help you keep out of trouble. It's vital stuff. So please – for your own safety – read through carefully.

3 Rules of the Waterway

Part three gives you the basic rules of the waterway.

4 Good Boating Behaviour

Part four is all about respecting the environment, the wildlife and other waterways users.

5 Further Information

Part five provides contact details for the navigation authorities and lists other sources of useful information.

The Boater's Handbook is designed for newcomers to boating, but we hope it will also be a handy reminder for more experienced boaters.

Read this handbook before you set off, and keep it nearby for reference. Of course, you won't become an expert overnight just by reading a book – and it's impossible to cover every aspect of boating, every type of boat and every eventuality. You'll find pointers to sources of local waterway information in part five.

Short courses in boat and unpowered craft handling are an excellent investment. **There are details on page 53.**

If you're hiring your boat, the operator will give you instructions. Pay close attention – and don't cast off until you feel confident!

Learn from the advice of local navigation staff, volunteers and other boaters you may meet along the way.

Who's in charge?

One of the great things about boating is that everyone can muck in together. But at least one person needs to know the boathandling basics, to understand the safety guidelines and to know what to do in an emergency.

So, once you've chosen a 'skipper', it'll be their job to make sure your crew and passengers have all the information they need to stay safe. It's a good idea to be clear on each crew member's duties.

Good boating takes teamwork. So you need competent crew who know how to handle the boat and how to stop the engine, and who can help with mooring, moving through locks,

navigation and so on. As well as knowing the procedures, your crew should be aware of the safety risks in each situation and how to avoid them. Someone should be competent to take over if the skipper becomes ill.

Think very carefully before going afloat alone as the risks are very much greater for you and other waterway users.

Passengers who aren't going to be helping with any of the work still need to read and understand the basic safety rules – so please show them the safety checklist at the front of this handbook.

Before setting off

Follow these simple tips for trouble-free boating.

- Check that your boat, engine and fuel system are in good condition and meet Boat Safety Scheme requirements.
See contact details on page 53
- Make sure you and your crew know how to handle the boat – and have the skills for the waterway you're using
- Get information on possible stoppages, stream conditions and tides and if you're planning to go on unfamiliar waterways check that your boat will fit through bridges and locks and that the waterway will be deep enough.
See contacts list on page 64.
- Plan your cruise and allow enough time to complete it without rushing. Add the number of locks to the number of miles and divide by 3 to get a rough idea of the minimum number of hours that a journey will take – it could take longer if there isn't much depth or you need to wait to use locks
- It's not a good idea to cruise in the dark or when visibility's bad – if you have to, take extra care
- Make sure you've got enough water and fuel on board for your trip
- Make sure you have a mobile phone handy and charged in case you need to use it in an emergency. Being able to make an emergency call could make all the difference if you get into difficulty, especially if tackling something with increased risk such as locking or river navigations.



Warning

Stay safe on the water – don't drink and drown. – Every year people die from drowning in the UK and alcohol is often a contributory factor. About a quarter of all drowning victims have alcohol in their bloodstream. Accidents do happen whilst boating and unfortunately the chances of things going wrong increase significantly the more you've had to drink. This is

why drinking and boating at the same time are the wrong ingredients for a cocktail of fun. Enjoy your boating, just remember to save your favourite tipples for after you've moored up for the day.

Boats come in different sizes, shapes and materials – and they all behave differently. Before you set off, spend some time getting to know your boat.

Boat jargon

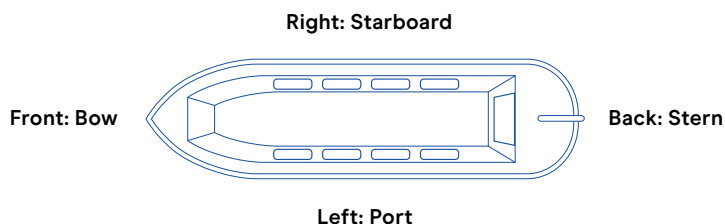

Special safety tips

Equipment checklist – Make sure you know where to find these things:

- Lifebuoy, lifeline (if supplied), lifejackets or buoyancy aids
- Anchor – for rivers and tidal waters, lochs and lakes – the rope and chain together should be at least six times as long as the deepest part
- Fire extinguisher(s) and fire blanket
- Emergency shut-offs for battery, gas and fuel
- Bilge pump
- Emergency torch
- Mooring ropes – long enough to stretch from your boat to the bollard and back, even when you're in a deep lock
- Mooring stakes and hammer
- Horn
- First aid kit
- Boat pole or hook
- Gangplank
- Windlass – **see page 22**

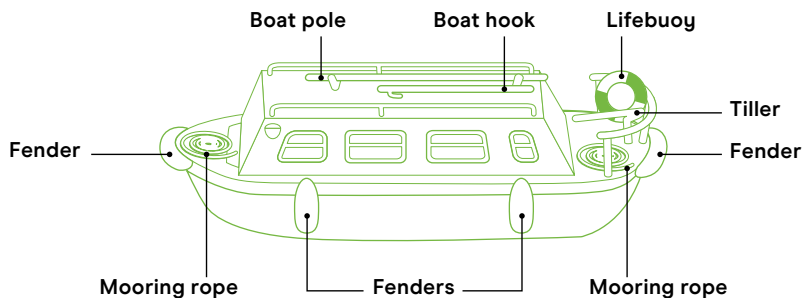

Setting off

Start the engine, keep it in neutral and allow some time for it to warm up before you move off. Once the crew are ready and the skipper has given permission untie the front and back mooring ropes from the bank, but leave them tied to the boat, coiled and ready for use. On rivers, untie the downstream rope first. Make sure your ropes can't trail in the water and get caught in the propeller. Don't forget to stow the mooring stakes and hammer.

Because the boat steers from the back, you can't drive away from the bank as in a car. Check the area is clear of boat traffic then push the boat away from the bank so you can make a clean departure, with your propeller in deep water. In shallow water, push the back of the boat out, then reverse away until there's room to straighten up.

When the boat's straight, go into forward gear and accelerate gently to an appropriate cruising speed.



Warning

Checking for weed or debris around the prop?

Turn the engine off and take the key out of the ignition. Remove the weed hatch and check the propeller. Take care when you remove any debris that is caught or wrapped around. It's a good idea to wear thick gloves. Fasten the lid back securely and, when you start off, look to check that it isn't leaking.

Under way

On all waterways, the rule of the waterway is to be on the right. On wide waterways this may be easy. But on most canals, unless there's another boat coming towards you, you'll steer down the middle as it's likely to be shallow near the edges.

When you do meet an approaching boat, keep to the right and pass 'port-to-port' (the left side of your boat passes the left side of the approaching boat).

Don't cut the corner when going round bends. You run the risk of a collision or going aground.

Read up on all the other rules of the waterways on page 57.

We want everyone to be able to enjoy our waterways safely. This means you need to be aware of other users and consider their needs.

Go slowly past boats, anglers and other waterway users.

Don't let your boat create a breaking wave or a lowering of the water along the bank just ahead of the boat. These are signs that you should throttle back to prevent damage to the bank and disturbance to moored boats. Excessive speed can also dislodge mooring pins.

Look out for swimmers, canoes, punts, rowing boats, sailing dinghies and anglers. Remember they cannot always see or hear you approaching. Slow down so that your boat isn't creating a wave. Give them plenty of room as you pass by. Warn other boaters coming in the opposite direction if you can.



Be safe around other craft and waterway users

Watch out for other waterway users – canoes, other unpowered boats or even swimmers.

Some vessels, such as loaded cargo vessels requiring deep water or vessels proceeding with the tide or stream, may have to pass 'starboard to starboard'. Such a vessel will indicate their intention by two short blasts to signify that

they will be altering their course to port. In such circumstances it is necessary to reply with a similar signal and to take similar action.

A vessel meeting or overtaking another vessel being towed from the bank should always pass outside the towed vessel and never between it and the bank.

Steering

Steering a boat with a **wheel** is like steering a car, but it's more difficult to judge where your wheel should be for going straight ahead. Get to know the feel of the wheel and the rudder position before you set off.

Using a **tiller** to steer is simple – as long as you remember that pushing to the right will make the boat head left and vice versa. Be patient and plan ahead – the boat will take a few seconds to respond.

Most boats pivot from a point about halfway along their length. That means you need to watch out for the front and the back. If you line up the front only and then try to turn into a narrow gap – a bridge or lock, for example – you risk hitting the side with the back of your boat. Watch out for currents or cross-winds pushing you off-course too.

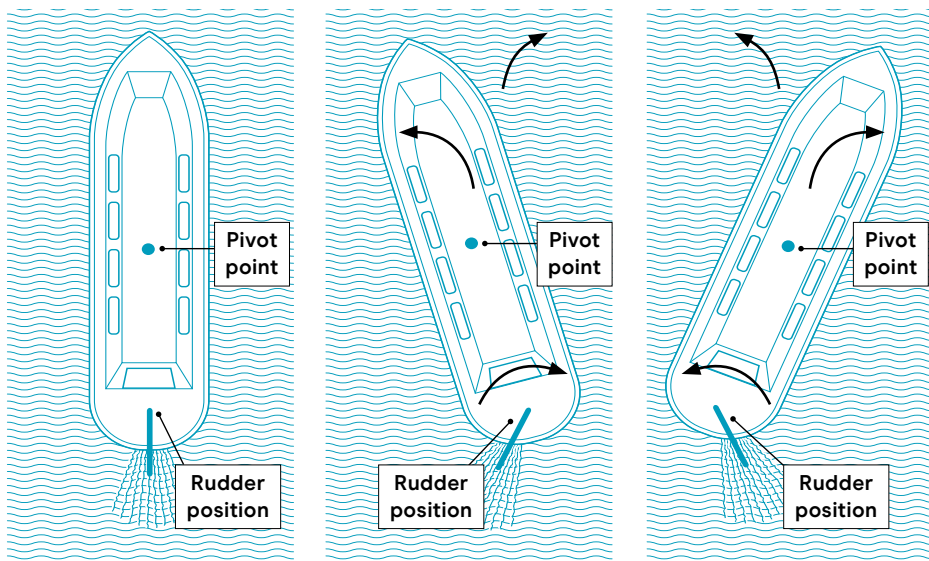

Warning

You can't steer unless your boat is in gear.

Remember – in gear and under way (no gear, no steer).

Going aground

Everyone goes aground at some point – **it's not a disaster**.

Don't try to force your way over the obstacle or you'll find yourself even more stuck. Instead, use reverse gear to back away into deeper water.

If you're firmly stuck, ask some or all of the crew to move to the side or back

of the boat that's still floating – but not to the extent that you'd risk capsizing! Now use the pole to push off against a solid object or the bed of the waterway – if you put the pole straight down and try to use it as a lever, it'll either break or you'll fall in. Keep the top of the pole away from your face and body, in case it slips suddenly.

Slowing down and stopping

Because boats don't have brakes, you need to give yourself plenty of time to stop – especially when travelling downstream on flowing waters. Ease off the throttle, move into neutral and then use reverse gear to slow down and come to a final halt. Opening the throttle to give more engine revs will

increase the braking effect when in reverse. Remember that it's extremely difficult to steer when you're in reverse gear. You may need an occasional forward boost to get better control.



Special safety tips

- Always be aware of what's happening around you – on the boat, in the water and on the banks
- Think ahead and make sure you're lined up for bridge and lock entrances well in advance
- On a traditional or semi-trad narrowboat, stand in front of the small rear deck and not beside the tiller so you won't fall off when making sharp turns or going into reverse. Don't let passengers stand or sit in the way of the tiller

Mooring

Prepare your crew in advance. Make sure they know what their jobs will be.

Slow down almost to a stop and carry out all your manoeuvres as slowly as possible.

Stop short of where you want to moor with your boat straight and in deep water. Move forward very slowly, pointing the front of the boat towards the bank, then use reverse to stop the boat just before the front hits the bank. Put the engine into neutral.

Your crew should step ashore – not jump. They can either carry the ropes with them – making sure there's plenty of slack and that one end is fixed to the boat – or you can pass them the ropes once they're on land.

On rivers you should moor with the front of your boat facing into the stream. This gives you more control as you slow to a halt. So, if you're heading downstream, you'll need to pass the mooring and turn your boat around. The same applies if you have a very strong wind behind you. It is easier to go past the mooring and turn your boat around so that you moor into the wind. Allow for the fact that the water level may rise or fall by several feet. If it's a tidal river, you should always moor facing the tide – and avoid mooring to the bank overnight.

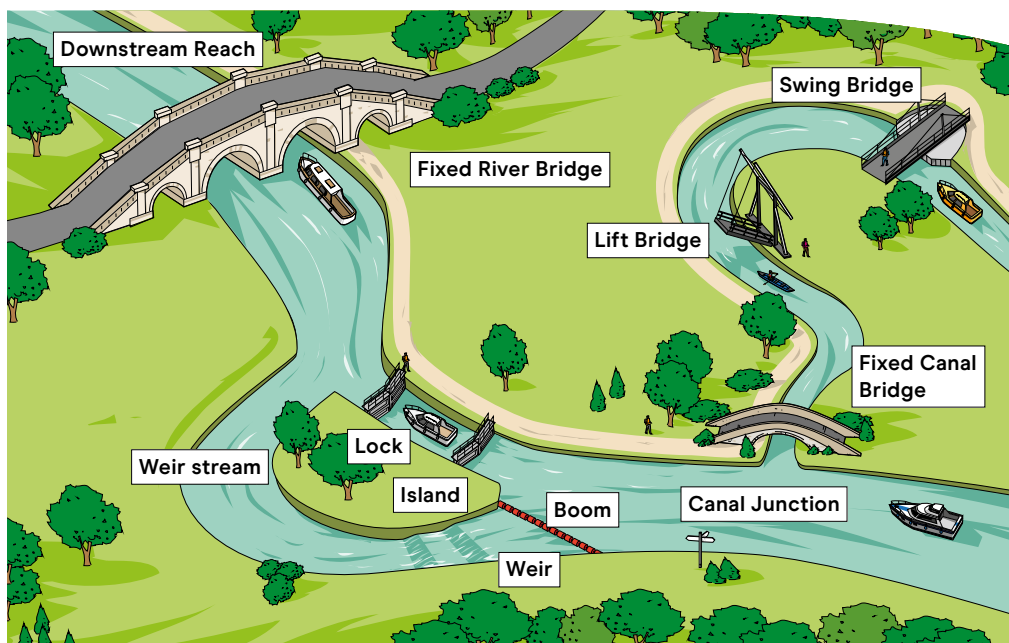

Can I moor here?

It's usually best to moor against the towpath or on signed visitor moorings. Many riverbanks and the non-towpath side of canals are private property.

Check that you're not a hazard to other boats or to people using the bank. At busy sites position your boat to leave room for other boats to tie up too. You could even encourage another boat to tie up alongside you providing it wouldn't interfere with boats passing by.

Respect any time limits. On Canal & River Trust waters, if there is no sign you are generally allowed to moor for up to 14 days. You may be charged for staying longer. Some moorings, particularly on rivers, charge from the day of your arrival. On other waterways mooring stay times vary, please check signage. If moorings are signed for disabled boaters, please give priority to those who need to use them.

Don't moor

- In locks, lock approaches or in lock flights
- Blocking taps and other services unless you are using them
- Near any bridges
- Under fixed bridges
- Near weirs
- Near sharp bends
- On the outside of bends
- By blind spots
- In or opposite turning points/winding holes or on the approach to these
- At junctions
- To the bank on a tidal river – you might find yourself hanging from the ropes when the tide goes out!
- On landing places for canoes – usually near locks
- In stretches marked out for an angling match
- Where there are signs that prohibit mooring



Tying up

To keep your boat secure, you need to tie it to the bank with a rope from both the front and the back. On rivers, you should fix your upstream rope first.

Many mooring sites have bollards or rings to tie up to – choose ones a short distance beyond the front and the back of your boat. Run your ropes at about 45° from your boat, loop them back onto the boat and tie securely, but not too taut.

To stop your boat moving backwards and forwards in flowing water, you can use extra ropes as ‘springs’ – see example below.

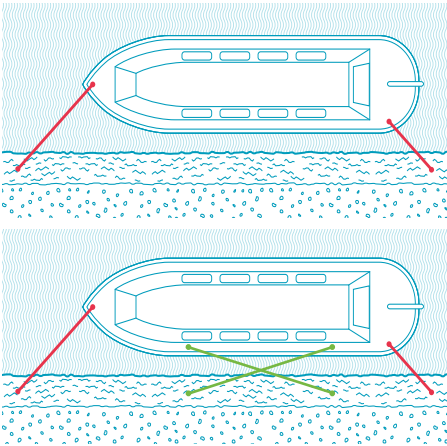

If there aren't any bollards or rings, use your mooring stakes if the ground is suitable. Do not attempt to hammer into concrete or other hard surfaces. If the ground is soft, check the stability of the bank and watch out for signs of underground pipes or cables before you start hammering. Position the stakes as far from the bank as you can, but don't tie your ropes across the towpath. Knock them in to about three-quarters their length and make sure they're firm. Mark them with a piece of light-coloured cloth or a white plastic bag or bottle so that other towpath users can see them clearly.

Leave some slack in your ropes – this is especially important on tidal waterways or rivers. If the ropes are too tight and the water level drops, your boat could be left hanging from the bank.

Remember that your anchor can be used if you need added security or extra help in a strong stream or tide – and you should still use mooring ropes.



Special safety tips

Make sure you know how to use your ropes properly.

Keep them coiled, free of knots – and don't drop them in the water, especially near a propeller. A rope can easily get wrapped around the propeller which will stall the engine and leave you with no way to control the boat.



Useful knots

Locking hitch

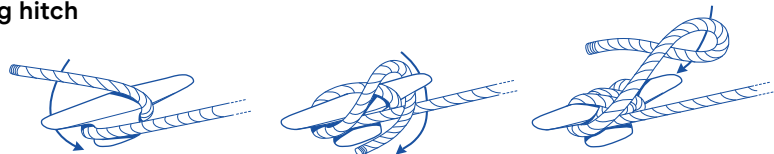

Round turn and two half hitches

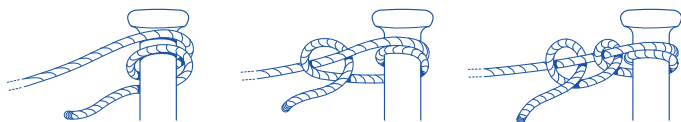

Quick release clove hitch

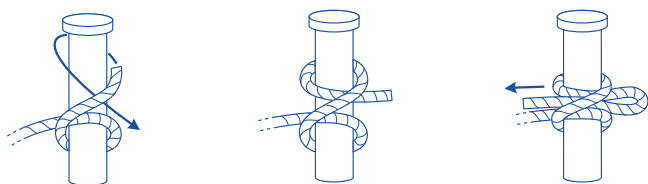

Canalman's hitch

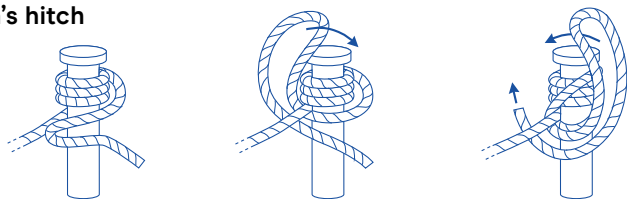

Bowline

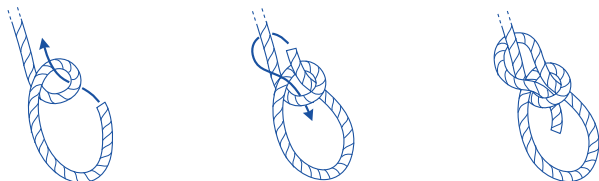

It's worth learning more about these and other knots. **See links on page 68.**

Locks

There's no mystery to using locks – just a series of step-by-step tasks. Understand the procedure, take your time and you'll be on your way with no problem.

A lock is simply a chamber with gates at either end. By emptying or filling that chamber with water, your boat can move up or down onto a new section of the waterway.

Although there are many different kinds of locks, they all work on the

same basic principle. With the lock gates closed, you open sluices or paddles to let the water in or out. When the water level under your boat is the same as the level you're moving to, you'll be able to open the gates to move in or out of the lock.

Some locks you operate yourself and others are operated by lock-keepers. Check your particular waterway for details. Always obey specific lock instructions and local information.



Special safety tips

- Take your time – and keep an eye out for problems
- Ensure that you use a tapered eye of the windlass on a tapered spindle, never the square eye
- Enter and leave slowly so bumps are less likely to cause damage
- Always have a competent person on board while the boat's in the lock
- Keep the stern of the boat clear of the cill when going downhill
- When going uphill, be careful not to get the rudder caught between the gates or to get caught on any projections on the lock wall
- Boats tend to bang about when water flows in and out of a lock – stay alert
- Make sure that you raise your side fenders when going through locks, particularly narrow locks
- Watch out for slippery surfaces when you're pushing the gates open
- Work out some clear signals so that the crew and skipper can communicate quickly – a signal that means 'close all the paddles,' for example
- Wait for the boat already in the lock to leave before you start opening or closing paddles
- Watch out for unprotected drops around the lockside, especially when opening gates
- If there is a bridge, use it when crossing the lock. If not, take care using the walking board attached to the gates – do not jump across part-opened gates
- Ask before helping other boaters with their lock operation
- Don't use a lock when it's discharging flood water (this only applies on some river locks)
- Never jump from the boat onto the lock side or layby, step off carefully
- Always bring powered boats to a standstill using the engine, not by trying to stop it using the ropes

Features of a typical narrow canal lock

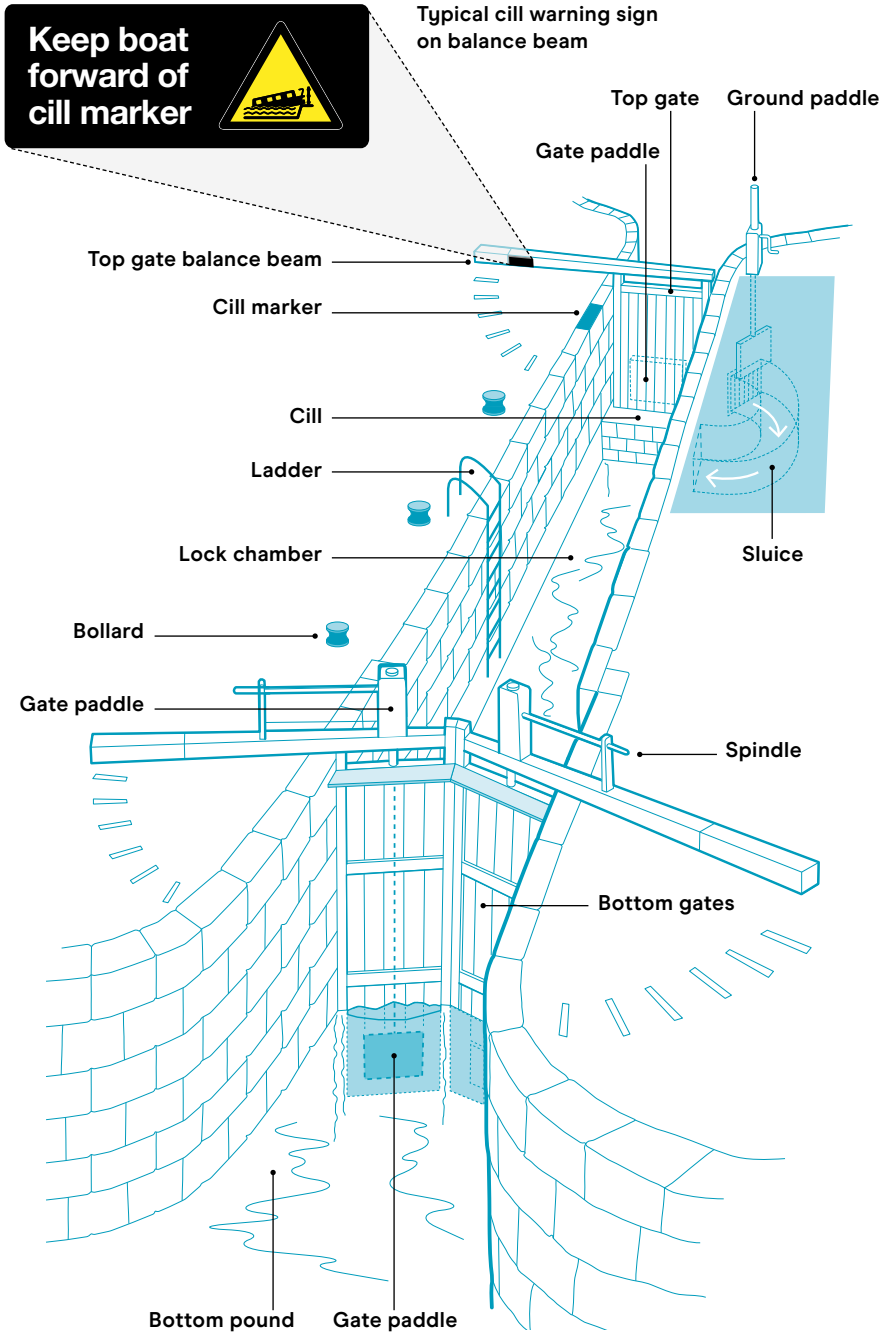

Going up

As you approach the lock, drop a crew member off to check whether it's full of water or empty. If it's empty, they can open the gates and you can steer the boat straight in.

If it's full, moor up below the lock, far enough away to avoid the currents while the lock is emptying.

If it's full your crew must look to see if there is a boat already waiting to come down the lock or one is approaching. Let them use the lock first. This will save water. When they leave, the lock will be ready for you to go in.

If there's no boat in sight check that the paddles at the top of the lock are fully closed down, then empty the lock by slowly raising open the bottom gate paddles. Open the gates and steer in.

Close the gates and the paddles (or check that these are already down if the lock was ready for you).

If there are ground paddles by the top gate, open these first. Wait until the lock is half full before opening the gate paddles. If there are only gate paddles, open them **very** slowly, and a little at a time, especially if the paddles are above the low water level.



Warning

This is what can happen if you open the gate paddles too soon. If this starts to happen, close the paddle(s).

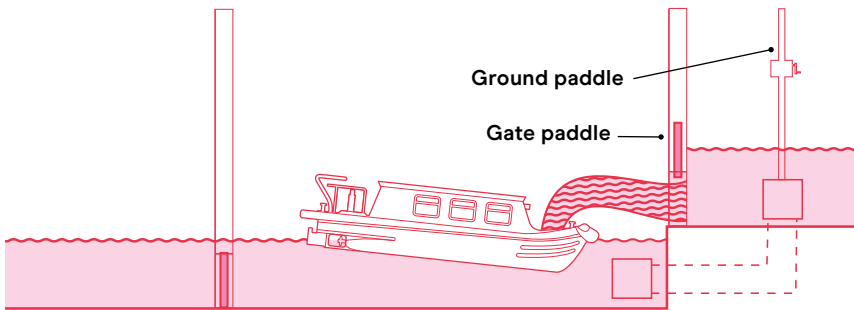

In wide and river locks keep your boat steady using front and back ropes looped round the bollards – take an extra turn around the bollard to stop the boat pulling you, but don't tie up.

In narrow canal locks many boaters prefer to use the engine to control the boat. If the top gate has a smooth rubbing board you can keep a steel boat steady by using your engine to push very gently against it as the water level rises. Others prefer to control the boat with ropes looped round the bollards.

When the lock is full, open the gates and move your boat out. Lower the paddles – and close the gates behind you unless a boat coming towards you wants to use the lock.

If the gates don't open or close easily, wait till the water level's absolutely equal.

If the gates don't open fully, close them and look for trapped debris, removing it with your boat-hook.

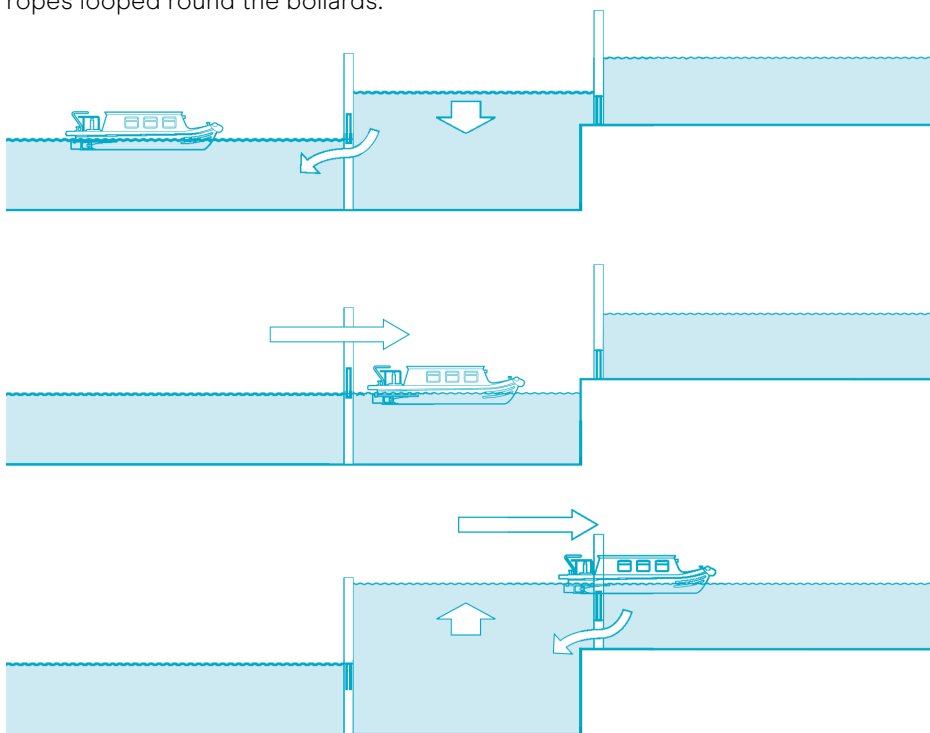

Going down

As you approach the lock, drop a crew member off to check whether it's full of water or empty. If it's already full they can open the gates and you can steer the boat straight in. If it's not, moor up while it's prepared.

If the lock is empty, your crew must look to see if there is a boat already waiting to go up the lock or one is approaching. Let them use the lock first. This will save water. When they leave, the lock will be ready for you to go in.

If the lock is empty and no boat is in sight, check that the bottom gates and paddles are closed and then fill

the lock by opening the paddles at the end nearest to your boat. When the lock's full, open the gate and steer in. Close the gates and lower the paddles.

Open the paddles in front of the boat (at the bottom gate) to empty the lock, using your engine or ropes to keep the boat as still as possible. Use ropes to keep your boat parallel to the lock side in wide and river locks.

When the water levels are equal, open the bottom gates and take the boat out. Close the gates and lower the paddles before you move on, unless a boat coming from the opposite direction wants to use the lock.

Warning

Keep the back of your boat well forward of the cill below the top gates.

Cills stick out by up to 5ft (1.5m) and you can only see them as the lock empties. Most locks have markers to show you the approximate position of the cill. If you are not alert, it's easy to get the back of the boat 'hung up' on the cill. If the boat starts to tilt like this, close all paddles immediately.

See instructions on refilling locks on p22.

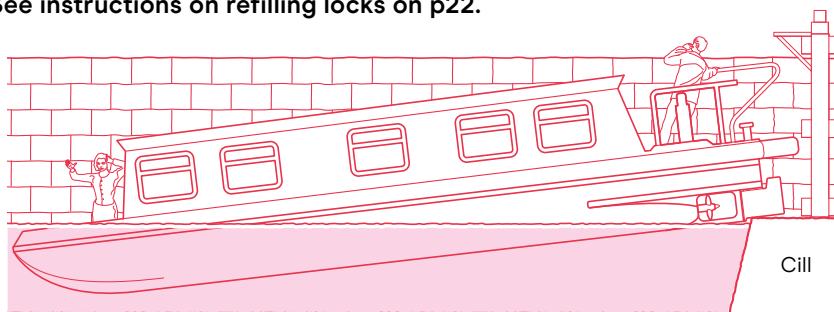

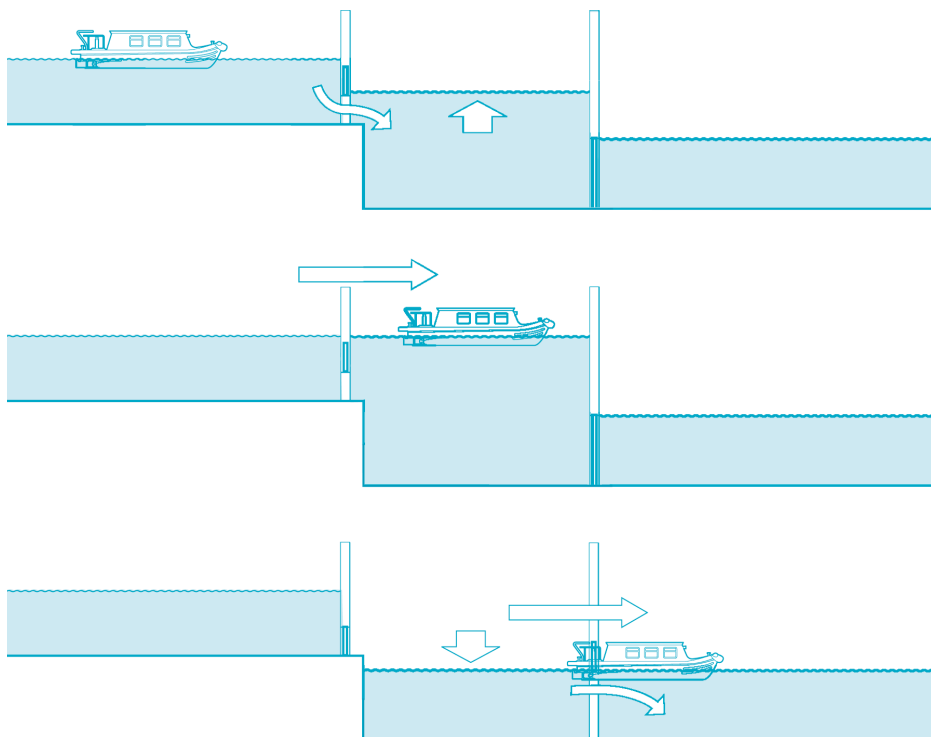

! Warning

**If someone falls into the lock, act quickly.
If there's no lock-keeper to take charge:**

- Close all the paddles
- Throw a lifeline or lifebuoy
- Stop the engine and keep the boat still
- If there's no ladder – or the person can't climb – you may need to fill the lock slowly to bring them up to your level. Or, if the lock is almost empty, slowly lower the water level, open the gate and draw the person to safety using the lifeline or a rope
- **NEVER** jump into the water yourself to rescue someone who has fallen in

Boat in the lock

 **Warning**
Floating freely?

As the water level rises or falls, keep a constant eye on your boat to check that it's floating freely.

If it does get caught or jammed, immediately close all the paddles and work out what needs to be done to get it level again.

→ **Going down** – If the side of your boat is caught against the lock wall or the back is caught on the cill close the bottom gate paddles to stop the water falling further. Slowly open the top gate paddles to refill the lock. Check for damage. If your ropes get snarled or too tight to let your boat move down freely slacken them off if you can. If not, refill the lock.

→ **Going up** – If the front of your boat is caught under part of the top gate or your rudder is trapped between the bottom gates, close the top paddles to stop the lock filling. Open the bottom gate paddles to allow the water level to fall.

If you're sharing the lock with another boat, make sure there's a safe distance between you. Use ropes looped round the bollards to keep you in position.

 **Special safety tips**

→ If you use ropes to keep the boat steady in the lock, don't try to take the full strain of the boat directly with the rope – wind it once around the bollard

→ Take special care not to let your fingers get between the rope and the bollard

Double windlass**Spindle types**

Parallel type
(Hydraulic gear)



Tapered type
(Mechanical gear)

Working the paddle gear

Upstream (top) paddles fill the lock. Downstream (bottom) ones empty it. Paddle gear can be either hydraulic or rack and pinion. On the rack and pinion type, remember to engage the safety catch before winding up the paddles. This stops the gears from slipping down. When you've finished winding the paddles up, check the safety catch is in position and then take off your windlass.

With one crew member at the helm and one at the paddles, you wind the paddle gear up and down using

a windlass or lock key. You should always wind them bit-by-bit – and keep an eye on the effect of the moving water on your boat.

To close the paddle, take the weight on your windlass, then lift off the safety catch and wind the paddle down – if you let it drop, the spinning windlass could injure you, especially if it flies off.

Paddle gear that it is enclosed often has an indicator to show how far it is open (up) or closed (down).

Rack and pinion paddle gear

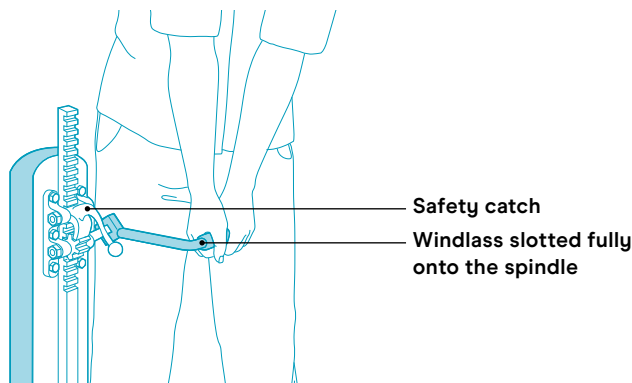

Special safety tips

- A flying windlass can cause serious injury! To avoid an accidental launch:
 - Keep a firm grip and don't let go
 - Only use a windlass that fits the spindle snugly
 - Make sure the windlass is fully slotted onto the spindle
 - Always use the safety catch when winding paddles up
 - Never leave the windlass on the spindle unattended
- Keep fingers, hair and clothing away from the mechanism

Sharing locks – saving water

Always share a lock if you can.

The heavier boat should go in first. This reduces the risk of, say, a steel hull crushing a fibreglass one. Also the water flow doesn't pull it into the lighter boat.

For unpowered craft such as canoes and kayaks locks, weirs and sluices can be very dangerous. Don't stay aboard your craft in a filling or emptying lock – carry it around. If it is too heavy, use ropes to keep control from the side.

In broad locks, boats should be kept to the side with ropes looped round the bollards. Slowly open the two paddles by equal amounts and at the same time if possible.

Some lock walls taper slightly from top to bottom so if you're travelling side by side with another boat, make sure there's plenty of room between you.

It's sometimes possible to get two short boats end-to-end in a narrow lock, but check that you both have enough room to avoid the cill and gates.

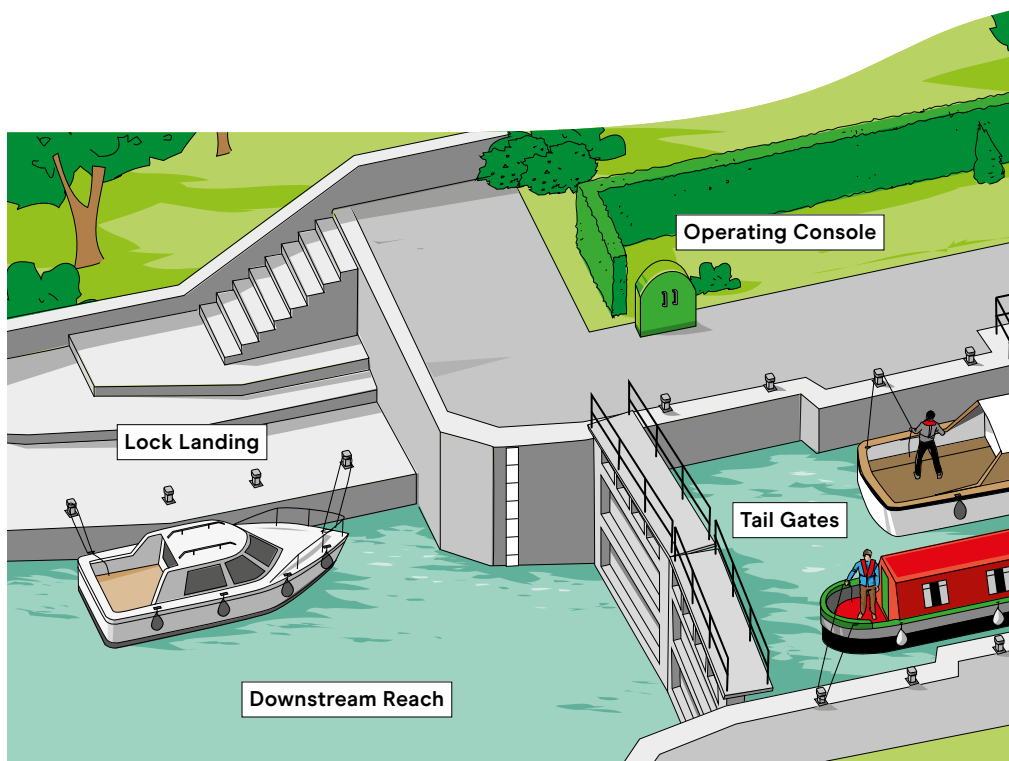

Powered locks

Some waterways – the Thames, Severn, and Trent, for example – have large powered locks, operated by lock-keepers.

If the gates are closed moor on the landing stage leaving room for other boats to land behind you, if possible.

Always follow the lock-keeper's instructions and local rules. On the Thames and Anglian waterways, for example, you must switch your engine off in the lock, and use ropes to control your boat.

Some locks (for example on the Severn) can only be operated by the lock-keeper. You can operate others (for example on the Thames and Trent) when the lock-keeper is not on duty.

If the lock has traffic light signals, amber usually means it is on user-operation and you should proceed with care.

If you are operating the lock yourself, follow the instructions that you will find at the operating console. You may need to use a navigation authority facilities key.

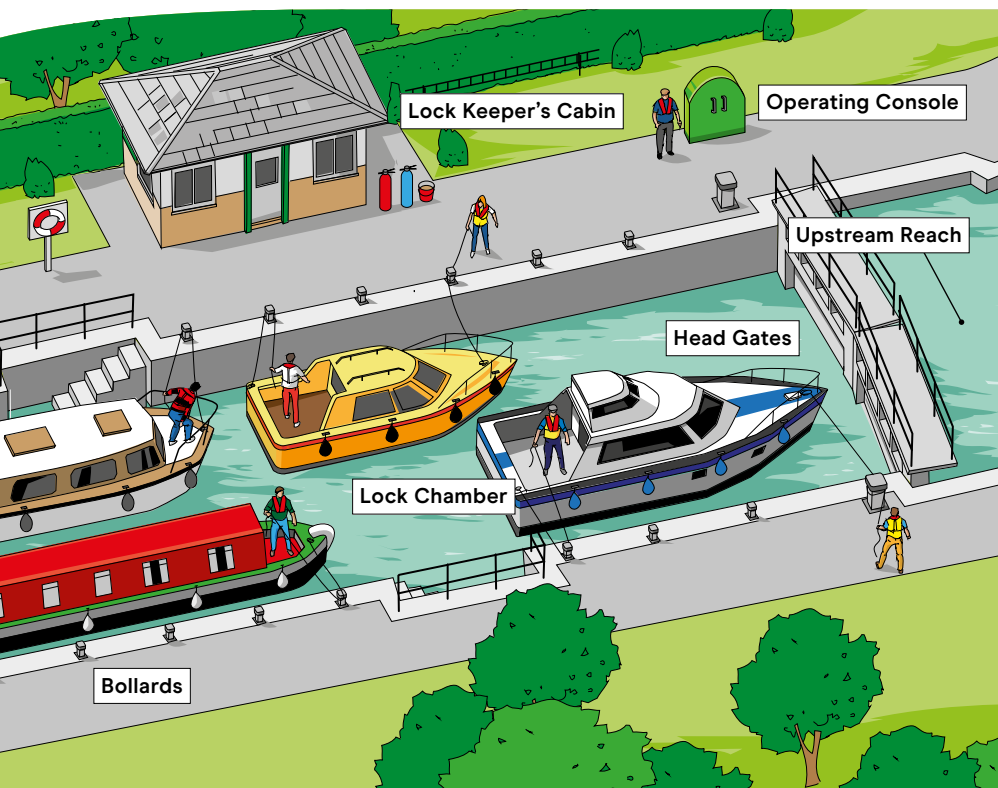

Guillotine gates

You'll find many locks with guillotine gates on the Anglian waterways. They have steel or wooden pointing gates – also known as mitre doors

– at one end, and vertical guillotine gates at the other end. Most are electrically-operated and some are wound up and down by hand.

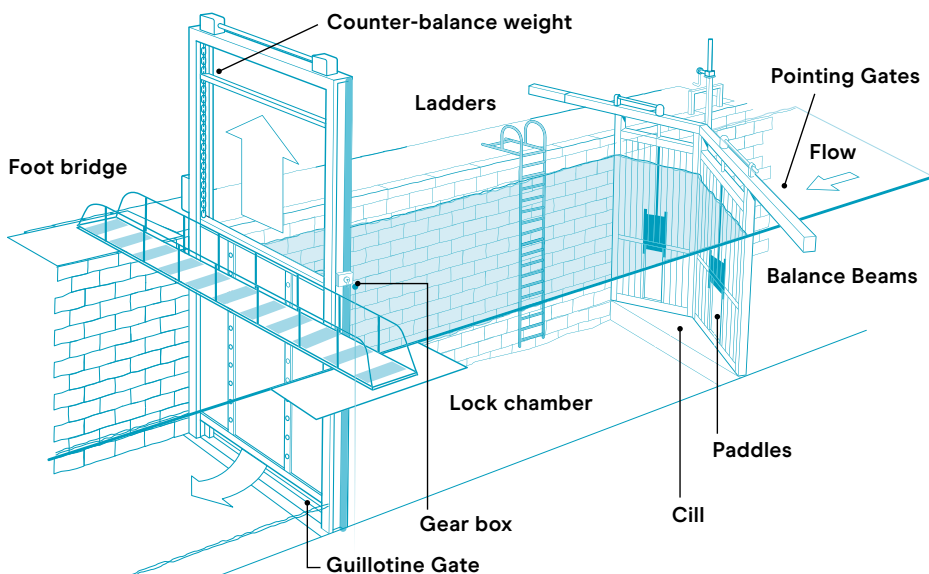

Special safety tips

- Make sure that the boat does not get caught on the lockside as the lock empties
- You may need to use fenders to stop your boat getting caught on the safety chains that run alongside the lock
- Some locks, notably on the Nene, may have water pouring over the top of the pointing gates. Keep your boat clear
- When you visit Anglian Waterways register for River Advice for Boaters. Call **0203 025 5068**, office hours, or email **WaterwaysSSAAnlian@environment-agency.gov.uk**

Gates open?

Go into the lock slowly and moor up. Make sure the guillotine gate, pointing gates and paddles (if there are any) are closed.

Depending on which way you're going, open the paddles in the pointing doors or lift the guillotine gate a few centimetres slowly. If the water flows in or out of the lock too quickly, close the gate and start again.

Guillotine gates that are electrically powered automatically open a little at a time to let water in or out slowly. Some guillotine gates in Yorkshire have gate paddles.

The crew in charge of the mooring lines should keep the ropes taut as water levels change.

When the water levels are equal, open the pointing doors or guillotine gate fully – depending on which way you're headed.

Gates closed?

Moor up at the landing stage and check that all doors, gates and paddles are closed.

Fill or empty the lock **slowly**. When the levels are equal, open the doors or gate fully, steer into the lock and follow the procedure above.

When you've finished using the lock close the paddles in the doors. When boating on the River Nene always leave the pointing doors closed and the vertical gate raised, secured and locked, unless directed otherwise.



Information

You need a key to operate locks on the River Nene, Great Ouse and the Ancholme, because the vertical gates have security locks.

Call the Environment Agency boating information number on page 64 for how to get one.

Reversed Locks

Following bouts of rainfall, some locks may have water pouring over the top of the pointing gates. Keep your boat clear of the overtopping water. The pointing gates are chained open and the guillotine gate is used as a sluice. The locks cannot be used and you are strongly advised to tie up when the river is flowing so strongly. **See boating safety advice on page 49 and 50.**

Staircase locks

Sometimes, you'll find two, three, four or even five locks joined in a staircase. That means the bottom gates of one lock are also the top gates of the next, and water from one lock fills the lock below. Usually you need to prepare all the locks before you start through the staircase. Check that another boat isn't already in the staircase coming in the opposite direction.

Never empty a lock unless the one below it is already empty. But bear in mind that locks should never be

completely empty – the lowest water level should still be deep enough to float your boat. Some staircase locks have markers to show you the level. Once you've prepared the locks, make sure all the paddles are fully closed.

If the water level isn't right, you could get stuck on the cill between the locks. If you do, just make sure the paddles below the boat are closed and slowly let the water into the lock from the lock above using the ground paddles only.

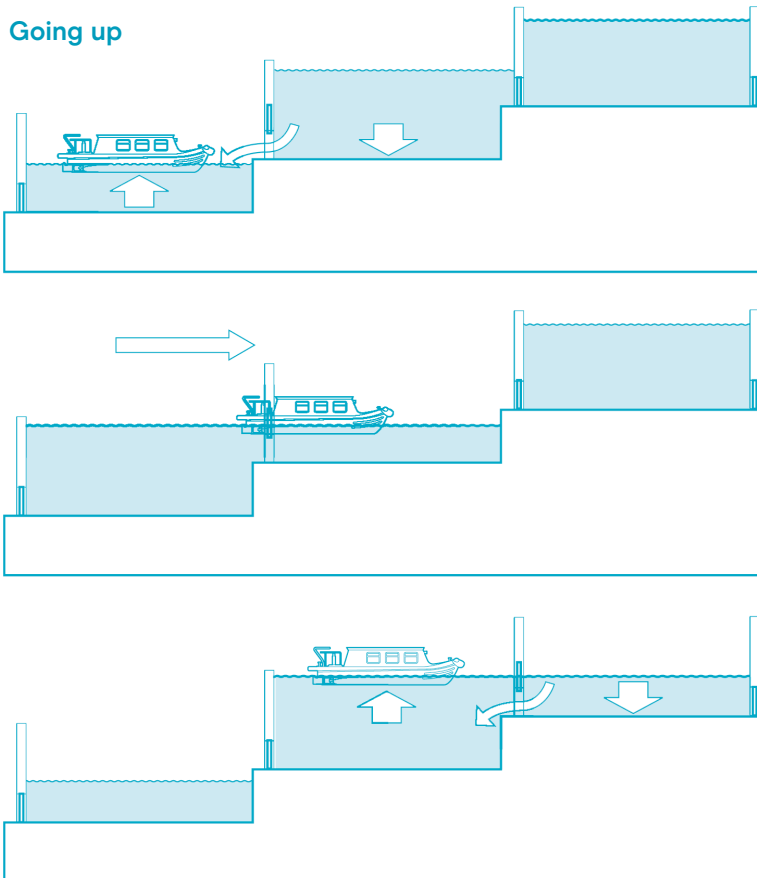

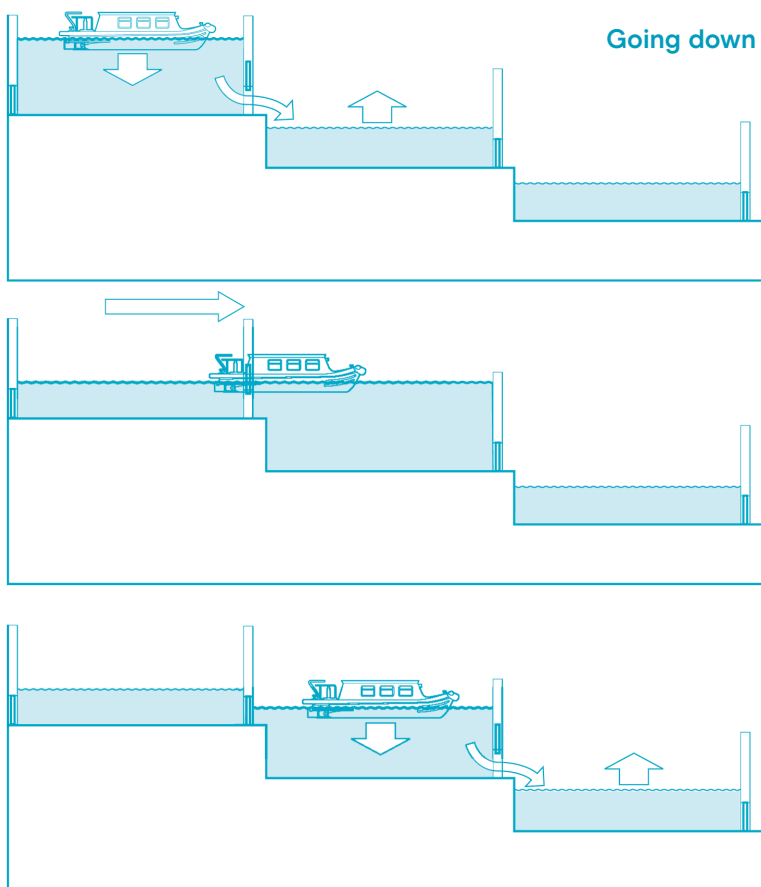

! Warning

Stumped by the staircase?

Usually if you're going up, the bottom lock should be empty and the rest full. If you're going down, the top lock should be full and the others empty. But this doesn't

always apply (for example, at the Foxton and Watford Flights on the Grand Union Canal) so do check local instructions, on a notice board or in your guidebook.

Bridges

You'll come across a whole range of bridges on your travels. Some are fixed and some need to be moved out of the way to let your boat pass.

Check your waterway guide for the sorts of bridge to expect on your journey.

Remember that many bridges have low headroom. On rivers, weather conditions upstream affect water levels – adequate clearance today might disappear tomorrow if water levels rise.

Bridges can be narrow too, which means river water tends to speed up as you get nearer. This can draw your boat towards the bridge, so stay alert.

Boats travelling downstream on rivers have the right of way at bridges and narrow sections.

Moveable bridges

Land your crew well before you reach the bridge – it gives you space to get the boat lined up straight to go through. They might need the windlass or navigation authority key.

If it's a traffic bridge, check that the road's clear and close the warning barriers if there are any. Don't forget to open the barriers once the bridge is back in place.

Manual swing bridges

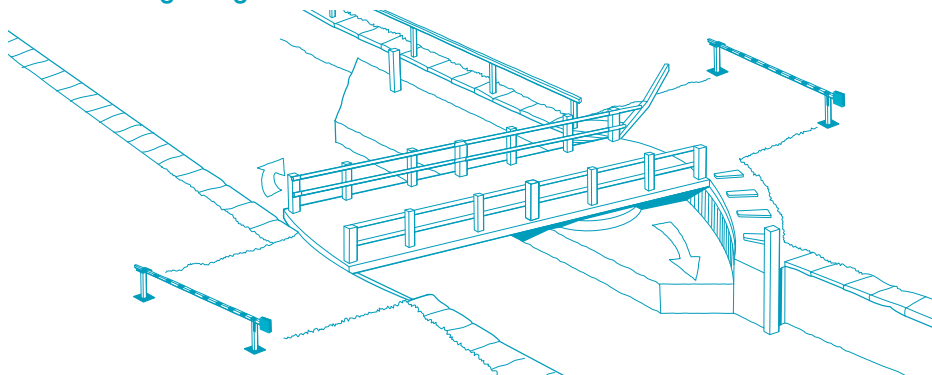

Unhook the retaining chain and give the bridge a good – but controlled – shove. You might need to slow the swing down to stop the bridge bouncing back across the canal when it hits the buffer stop.

When the boat's through, push the bridge firmly into place and put the retaining chain or lock back on.

Manual lift bridges

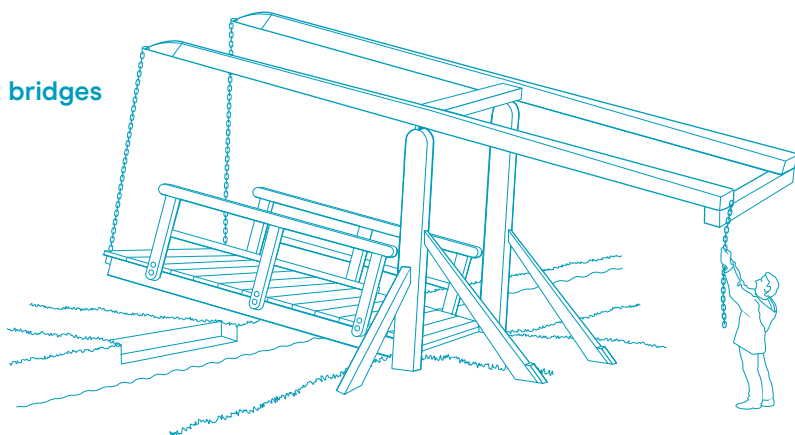

Pull the chain hanging from the balance arm. When the bridge is open, unless it's obvious that there's a mechanism to stop the bridge from lowering by itself, sit an adult on the arm to keep it raised until the boat's clear of the bridge.

Gently lower the bridge by the chain, taking care not to let it drop.

Mechanised bridges

Mechanised bridges are either opened using the windlass, or are powered and need a navigation authority facilities key. Often you can't move the traffic barriers until you've unlocked the control box. And you can't move the barriers back again until the bridge is back in its original position.

Some modern bridges have wedges so they don't bounce when cars cross them. You should find instructions

at the bridge on how to release them. Please make sure they're back in place before you let traffic back over. Otherwise vehicles will damage the bridge mechanism.

Some bridges are operated by bridge-keepers. Look out for traffic lights that tell you whether the bridge is ready for you to go through. Don't try to pass under them unless instructed by the bridge-keeper.

Warning

Bridge trouble?

If a bridge breaks down, don't try to force it. Call for help. There should be a phone number on the bridge

instructions. If not, call the local navigation authority office. **See page 64 for contact details.**



Special bridge safety tips

- Don't try to take your boat through until the bridge is fully open and secure – they can stick at the wrong moment
- Take care with clearance under lift and fixed bridges and stay in the centre of the channel
- Keep everyone off the roof and within the profile of the boat
- Watch out for slippery surfaces when you're pushing swing bridges
- Use strong, fit crew to operate moving bridges
- Take care to stay clear of the sides of the boat to avoid the risk of trapping someone against the cabin bulkhead

Winter cruising

- **Strong streams and rapidly rising water levels are much more likely.** Check conditions with the navigation authority before setting off. **See page 64 for links**
- When tying up **leave enough slack** in your ropes for changing water levels
- **Make sure any rainwater that collects in the bottom of the boat is pumped out**
- Unless your journey is really necessary, **don't cruise through ice.** Even thin breaking ice can puncture timber and fibreglass hulls. Thicker ice can also damage steel hulls of boats that you pass, or your own
- **Watch your footing** at all times
- Don't take risks – **wear a life jacket**
- **Wear gloves to stop your hands sticking to icy surfaces**
- **Wrap up warm** – good insulation will help prevent hypothermia
- **All heating systems need enough oxygen to burn safely.** Without it lethal levels of poisonous carbon monoxide gas can build up. Prevent this by having appliances and flues properly installed and serviced and ensuring there is adequate ventilation
- **Make sure nothing blocks your ventilators** – like tarpaulins or snow
- **Fit a carbon monoxide alarm** suitable for use in boats. **Look for one marked with the standard: BS EN 50291-2**
- **Don't put wet or unseasoned wood in solid fuel stoves.** You will block the chimney with tar and soot, risking fire and carbon monoxide poisoning. The smoke will also irritate anyone nearby

Wide beam boats

If you've a boat wider than 7ft, or are thinking of upgrading or buying one, what sort of things should you consider?

- Budget – bigger boats generally cost more to buy, and wider boats also pay a higher licence fee on Canal & River Trust, Environment Agency and some other waters!
- Cruising – width is probably the main limiting factor (especially at bridge holes and locks), but it's worth pointing out that even if none of the visible structures will impede you, the navigable channel might – narrow canals are not dredged for passing wide beams – you could find yourself running aground on a narrow canal every time an oncoming boat needs to pass you, potentially damaging your boat and the canal. Refer to the map on **page 63** that indicates which waterways are suited for wider craft and also check out our '**Waterways Dimensions**'. For more detailed information visit www.canalrivertrust.org.uk/planning-your-boat-trip
- Mooring – wide beam boats take up more of the channel even when moored up. This just means you need to be extra vigilant that you're not causing a navigation hazard by obscuring line of sight for other boaters or mooring opposite a boat on the other bank
- Location – consider the location you buy your boat and where you want to cruise and moor (unless you're prepared to pay for a contractor to move your boat by road). If you don't have a home mooring in that area then you need to be able to comply with the '**Guidance for boaters without a home mooring**'. For more detailed information visit www.canalrivertrust.org.uk/continuous-cruising

Powered & unpowered craft

Powered and unpowered craft regularly share the use of the canal and river navigations and by following some basic precautions the waterways can be shared safely. Many of the waterways are popular with rowers, paddlers including stand up paddle boards (SUPBs) users and other unpowered craft.

Follow the general rules of navigation, signage, any local bye-laws and navigation notices issued by waterway authorities.

In some areas of the Canal & River Trust network water sport zones have been established. **See page 59.**

Respect and do not obstruct other water users.

Tunnels

Tunnels can be narrow with only room for one-way traffic, or they can be wide enough for two boats to pass. Check for instructions, entry times or traffic lights at the tunnel entrance.

If it's a one-way tunnel, make sure there's no boat inside. If you have to wait your turn, stay well clear of the entrance.

Switch on your headlight and some interior lights. Some stern lighting will help a following boat to see you, but if it's a single bright spot or rear navigation light, it might be confused with a headlight by the helmsman of a following boat.

It can be cold and damp in there, so put on warm clothes and waterproofs and have a waterproof torch to hand.

As you go in, sound one long blast on your horn. Now steer by looking at one side of the tunnel only and keep

to a moderate speed. Move the tiller or wheel as little as possible – it's a common illusion to feel the boat's being pulled to the side. You might find it helps to shine your torch on the tunnel wall. Watch out for the changing profile – tunnels are rarely straight and the headroom can change.

Keep at least two minutes (at normal cruising speed) or about 500ft (160m) away from any boat in front of you. If it's two-way traffic, keep a look-out for oncoming boats and pass slowly on the right.

Watch out for canoes or other small unpowered boats that might be in the tunnel. These should carry a white light.

Passage through some Canal & River Trust tunnels now require pre-booking online or by phone. Please check the website or call the Trust for more details.



Special safety tips

- Keep your crew and passengers inside the boat
- Make sure you have enough fuel to get you through
- If you break down in a tunnel, switch off the engine
- Don't smoke or use cookers and heaters. Turn off the gas except pilot lights
- Make sure the air controls are set to prevent a solid fuel stove over-firing
- Watch your head, some tunnels have low and variable headroom. Never stand on the gunwales when entering a tunnel
- Don't allow inside lights to shine into the steerer's eyes
- Make sure you have a torch
- Most tunnels have a chain fixed to one wall near the water level to help if someone falls in
- Reflective signs on the walls of long tunnels point to the nearest end
- It is advisable to wear a life jacket when traveling through tunnels
- Please check the Canal & River Trust website for additional safety advice related to specific tunnels, for more detailed information visit **www.canalrivertrust.org.uk/boating-through-tunnels**

Unpowered craft in tunnels

If you are in canoes or other small unpowered boats, for your own safety you should think very carefully before deciding to navigate through a tunnel. These are the Canal & River Trust criteria for permitting canoes and other small unpowered boats to pass through a tunnel:

- A forward facing bright light is displayed by all craft using tunnels including unpowered
- The tunnel is less than 400 metres long, and there are good sight lines through the tunnel
- The tunnel is between 400 and 650 metres long, and there are good sight lines, AND a single way traffic system is in place
- We don't allow passage through other tunnels unless it's part of a managed event for which we have given permission
- Exceptions may be made on the basis of local risk assessments taking account of factors such as potential smoke and fumes, existence of towpath/grab chains etc

For your own safety if you are in an unpowered craft:

- Always stop and check the tunnel port signage to ensure that the tunnel is open to unpowered craft and for other information such as the length
- You must use a forward facing bright light (such as a head torch not less than 80 Lumen)
- You are strongly advised to wear a buoyancy aid/lifejacket
- Download a list of Canal & River Trust tunnels open to small unpowered craft from the website www.canalrivertrust.org.uk/canoeing-safely

Variable headroom sign

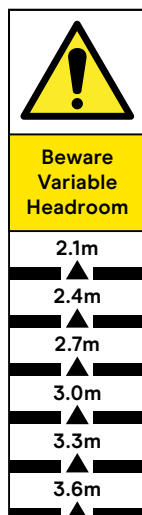

Accidents

Now we've shown you the safe way to do all the main boating things, we'd like to say a bit more about accidents. Tranquil waterways, beautiful scenery, fresh air. Boating on our canals and rivers is a real pleasure – and, most of the time, there are few safer ways to travel.

Accidents and injuries are rare, but every year a few people do get hurt – usually through inexperience or not paying attention. If you do have an accident or near-miss, you should report it to the navigation authority office or member of staff on the bank. Your report could help to save others. **For contact details see page 64.**

By looking at the accidents people have had on boats over the past few years, we've found that they fit into a relatively small number of categories. This part of the handbook looks at the causes so that you can avoid the same misfortune.

Falls

Wherever you are – home, work or on a waterway – the most common accidents are slips, trips and falls. But when you fall off a boat or from the waterside, those accidents can be more serious.

Apart from the risk of drowning, you could be dragged or fall into a moving propeller. You could hit your head, or be crushed between your boat and another object. There's also a slight risk of infection from the water itself (see page 52).

Boats and watersides are littered with bollards, rings, ropes and holes. Surfaces can be uneven or slippery, particularly in wet or icy weather or early morning dew. So you need to keep your eyes open – and slow down.

Many falls happen during mooring – simply because people aren't sure of the procedure.

There are unprotected drops at locksites. Watch out especially when operating lock gates.



Warning

- Over half of all serious accidents to boaters are caused by falling off the boat, towpath, bank or jetty. Many happen even when the boat is tied up.
- Don't leave the helm when the engine's running. If someone falls into the water, they could be injured by the moving propeller. And don't leave the keys in the ignition unattended. Never run the engine in gear when the boat's moored up.

What causes falls?

- Trips over ropes, mooring stakes and so on – especially when left untidy
- Walking on narrow decks on boats that tend to rock
- Jumping off or stepping off in a dangerous place
- Slipping on a wet deck
- Moving about the boat or waterside at night
- Too much to drink

For more safety tips for boaters visit www.canalrivertrust.org.uk/water-safety-tips-for-boaters

Safety essentials

- Watch out for collisions – and if you are going to bump, warn your crew and passengers to brace themselves
- It is safer to walk through the inside of the boat to get to the front or back
- If you have to walk round the outside use the grab rail – ‘one hand for the boat, one hand for you’
- Keep your decks clear of clutter to avoid trips
- Don't jump off the boat when mooring
- Wear non-slip deck-shoes
- Take extra care on towpaths at night. Use a torch and watch out for ropes and mooring pins
- Don't sit or stand on the roof of the boat



Warning

Don't let small children move around the boat unsupervised. Always know where they are and make sure children are wearing a life jacket at all times.



True stories

Eyes in the back of your head?

Eleven-year-old Sam was lucky to escape with a broken arm when he fell onto the deck of a boat as it passed through a lock. While the rest of his family – relatively experienced holiday boaters – were busy with the 60ft narrowboat, Sam ran along the lockside, tripped over a bollard and fell over the edge. Luckily, the lock-keeper was on hand to rescue him.

Fire, explosion and fumes

Although rare, boat fires and explosions can be fatal. There are some specific risks to be aware of.

The bottled gas used for cookers, fridges and heaters is heavier than air and, if there's a leak, it'll build up in the bottom of the boat. A small spark will ignite this gas.

Petrol vapour is also heavier than air and highly flammable. If there's a strong smell of gas or petrol, follow the drill shown opposite.

And lastly, you need to watch out for fumes from cookers, cabin heaters and water heaters or from engine exhaust building up in the boat.



Special safety tips

- Boat appliances and their fuel systems need regular checks and professional servicing. Any changes should meet Boat Safety Scheme requirements
- Learn how to refuel safely
- Avoid refuelling any portable engine or tank aboard the boat; take it to the bank and a safe distance from any boats or other sources of ignition
- Never store petrol, diesel or gas containers in the cabin or engine space – even empty ones or only for a short time. The same applies for portable generators
- Ensure all electrical circuits are protected by appropriate fuses or circuit breakers
- Look and listen for signs that electrical cables are overheating
- Make sure appliances aren't faulty
- Keep ventilators open and free of obstructions
- Fit a smoke alarm and carbon monoxide alarm suitable for use on boats and press the test button routinely
- Make a fire action plan with your crew to help your escape if the worst happens. Make sure you know where your fire extinguishers and blankets are, and how to use them. Keep escape routes clear
- Never lock or bolt doors and hatches on the outside while you're onboard

Warning

Hey! I can smell gas (or petrol)!

Close the shut-off valve and open windows, hatches or doors to ventilate the area as much as possible. Turn the engine off, and put out naked flames, cookers, pilot lights and cigarettes. Evacuate the boat if possible.

Don't switch anything electrical on or off, including lights and the bilge pump, until you're sure the gas/petrol has dispersed. Find the problem and get it put right before you turn the gas or fuel on again.

Fire! Act quickly – fire spreads rapidly! Put your fire action plan into practice! Alert everyone on board to move to a safe location

and evacuate if possible. Use a fire blanket on pan fires, and fire extinguisher on other fires. They can help you escape or might put out a small fire. Keep them in good condition and ready for use.

If the fire's taking hold call the fire service if you can. If the fire's in the engine space, don't open the main access – the air will only feed the fire.

If someone's clothes are alight, quickly lie them face down so that the flames rise away from their face. Smother the flames with a blanket or wet jacket, laid away from their face. Call the emergency services.

What causes injuries from fire, explosion or fumes?

- Dangerous misuse of equipment or the failure of some parts of the fuel, gas or electrical system
- Unsafe handling or stowage of petrol and gas containers. These must be kept in purpose-built compartments and never left in cabins or engine spaces
- Poor ventilation, leaking flues and a build-up of petrol engine exhaust fumes
- Check the location of all flue terminals
- Check for the presence of a canopy or canopy fixings where a flue terminates at any part of the vessel which could be enclosed by a canopy
- Flue terminals must be located outside the interior of the vessel and outside of any areas which may be enclosed by a canopy
- Ensure that fumes from generators or other appliances cannot blow under and get trapped under enclosed canopies



True stories

Too hot to handle

It was a cold evening and John went ashore for a warming curry. He banked up his stove with fuel to keep the boat cosy for his return. But while he was away the fire raced out of control. The

wall and curtains near the super-hot chimney were smouldering when John returned. If he had lingered half an hour longer over his curry, he would have returned to a burnt-out shell of a boat.

Solid fuel stoves

- Don't bank up your stove with fuel and leave it unattended whilst going off for a day's work, a spot of shopping, or bite to eat
- Before leaving the boat for a period, going to bed, or travelling through a tunnel set the appliance air controls to prevent over-firing

If you feel unsure about how to install or run your stove, or if you've been checking it over and what you've found leaves you in doubt about your safety, ask a professional for advice or to fix any problems.

Ventilation

It is now known that solid fuel stoves consume huge amounts of oxygen in use. Ensure that the air control on your stove provides sufficient air flow.

Have you blocked up or closed some ventilation? Keep boat ventilation clear, stoves need lots of oxygen to run efficiently.

Most stoves are not made to be run with the loading door open, so keep it closed. Ensure that there are no leaky seals on the door and flue.

Safe re-fuelling of petrol engines and generators

- Stop the engine, switch off ignition systems
- Put out all naked flames including pilot lights
- Evacuate the boat if possible
- Vapour will travel, so protect the boat by closing doors, windows and hatches
- Never refuel in a lock or next to another boat
- Refuel outboard tanks and generator tanks ashore, well away from the boat
- Wipe up any spillage immediately and securely replace the cap on the can



True stories

Breathe easy!

A sunny autumn weekend? Perfect weather for a day's cruising. But when the night turned chilly, this boating couple blocked off the draughty ventilators and lit the gas central heating. When their

friends came back from the pub, they found the couple unconscious from carbon monoxide poisoning. Had they stayed for a last drink, the result would have been far worse than severe headaches.



Warning

Take special care to avoid the risk of electric shock and fire if your boat has a 230 volt electricity supply – it will be more exposed to vibration and water than in your home.

- Use a competent person to design, install and maintain your boat's electrical systems and appliances and to make any changes to them
- Don't ignore danger signs like burning smells and scorch marks
- Know where to find your main switch
- Test that your circuit-breakers work

Taking these points into account, more care needs to be taken with 230 V electricity on boats, including:

- Avoiding water coming into contact with electric equipment or wiring
- Ensuring the boat's different sources of electric power – shore power cables, engine-driven alternators, inverters and installed or portable generators – are never connected to each other or to the same wiring at any time (usually only possible due to careless or incompetent electrical work)
- Using shore power cables responsibly, and always ensuring that an effective earthing connection is made, via the cable, from the shore power socket to power inlet on the boat (and hence to the main earthing terminal of the boat's electrical system) when the cable is connected

Find out more from the **Boat Safety Scheme website (see page 53)**.

Collisions

Collisions – with other boats, banks, bridges or other structures – are another common cause of injury. The impact can lead to falls, both onto the deck and into the water. And for people working in the galley, there's a risk of scalds or burns.

What causes collisions?

- Lack of boat-handling skill or experience
- Taking your eyes off the waterway
- Cruising too fast

Safety essentials

- Check headroom for bridges. Remember bridge shapes vary and water levels rise
- Watch out for cross-wind. You can anticipate it by looking for ripples on the water and swaying trees. You may need to steer at an angle into the wind to avoid being blown off course

- Be ready for strong flows at locks, weirs and places where water is taken in or out of the waterway
- Give a long blast with the horn as you approach blind bridges, bends and junctions
- Look out for canoes, sailing dinghies and other unpowered boats
- Watch out for floating tree trunks and other debris
- Learn the Rules of the Waterways. **See page 57 for details**
- Make sure you know the size of your boat and the dimensions of the waterway you're cruising on
- Not all waterways are suitable for wide craft. Please check with the relevant waterway to find out which recommended for wider craft. **See page 33 for more detail.**



True stories

Blast it!

Neither skipper sounded the warning when a small cruiser and a family on a first-time boating holiday met at a blind bend. The collision sent a sunbather flying from the deck of the hire boat. The quick-

thinking helmsman stopped the propeller just in time, and the girl was rescued unharmed. An elderly woman on the cruiser wasn't so lucky – she'd been making tea in the galley and was badly scalded.

Crushing

If your boat collides with something else, you don't want to be in the way. Don't put yourself between the boat and a bank, tunnel or bridge, or you could end up with crushed fingers or legs – or even more serious body injuries. Don't get your body in the way of a moving bridge or lock balance beam.

What causes injuries?

- Using your hands or feet to stop a collision or fend off
- Not appreciating the momentum or the size of your boat
- Lack of attention operating bridges and locks

Safety essentials

- Keep your body out of the way
- Keep within the boat – that means not having your legs dangling over the side, your hands over the edge or your head out of the side hatch
- Keep off the roof when underway
- Don't fend off with your arms, legs or a boat pole – let the fender take the impact
- Make sure anyone in the front cockpit is on the look-out for possible collisions and ready to escape into the cabin
- Supervise children who are helping



True stories

Helping hand – broken ankle

A couple, invited along for a canal cruise by their neighbours, were eager to help. So, approaching a mooring, the husband leapt to the front of the boat with the mooring rope. Seeing the boat

was about to hit the bank, he instinctively stuck out a foot to fend off. His pleasure trip ended with a broken ankle, crushed between the boat and the bank.

Capsize

All boats have a limit to the number of people that can safely be on board. Look for a plate showing the number or get it from the boat's handbook or safety information folder.

Think carefully before going on the cabin roof as the boat could become top heavy and roll over. Obey any sign or instruction that limits people on the roof.

Don't let everyone stand together on the same side if it risks tipping the boat over.

Man overboard

Before you do anything else, take a breath and think. Don't panic, don't jump in – and don't let others jump in. The water is very cold even in summer. Keep sight of the person in the water at all times.

On narrow canals and slow, shallow rivers

Put your engine out of gear. Don't reverse the boat – the person in the water could be dragged into the propeller.

Throw a line or a lifebelt and tell them to try to stand up – if it's a canal they might be able to walk out.

Steer the boat slowly to the bank and get one of your passengers off to help the person get out of the water.

On wider or deeper waterways

Throw a lifebuoy to the person in the water. Keep a constant watch to ensure your propeller is well away from them. Stop the propeller immediately by selecting neutral gear if there's a risk of them getting close to it. If you are on a river you may need to turn so as to approach them slowly going against the stream.

Pull them to the side of the boat and help them aboard with a ladder, rope or pole.

Be prepared

Make sure everyone on the boat knows the drill – and knows where to find the lifeline or lifebelt. In case it's the skipper who falls overboard, the crew should also know how to stop the propeller and steer the boat.

Practice the drill. It's better to learn it before an accident happens.



True stories

Tipping tragedy

Two families were enjoying a trip out on the Norfolk Broads aboard a fibreglass boat they had hired for the day.

Five of the party were sitting on top of the front cabin roof as they cruised along. Their weight was all

on one side of the boat causing it to become unstable and capsize.

One of the mothers was trapped under the upturned boat and despite frantic efforts to rescue her, tragically, drowned.



Should I wear a lifejacket?

Children, non-swimmers, those with disabilities and lone boaters should wear lifejackets whenever they're on deck. And that applies to everyone if you're negotiating tidal waters, strong streams or currents or if the decks are slippery and whenever the water is likely to be cold.

Of course, it's always safer to wear a lifejacket or buoyancy garment. You could be knocked unconscious. Rivers and deep canals can give disabling cold shock even in summer. It is difficult to swim when fully clothed.



Warning

It can be dangerous to swim in waterways. You could:

- Get cramp or breathing difficulties from the shock of cold water
- Be swept away by strong streams or currents
- Get tangled in weeds or junk
- Get cut by rocks, glass or wire
- Be hit by a passing boat
- Get drawn into a sluice or weir
- Catch a waterborne disease

Swimming is not permitted in canals owned by the Canal & River Trust.

Operating injuries

Boating can involve a lot of physical exercise. Some of the work is heavy and you'll also be using unfamiliar techniques and tools. Together, the two things can add up to strained backs and muscles, cuts or worse.

What causes operating injuries?

- Overstretching yourself
- Using tools or equipment incorrectly
- Not paying attention to the job in hand
- Rushing
- Not preparing properly

Safety essentials

- Take things easy. Don't strain. Share the work
- Let the fittest operate locks and bridges

- Make sure you know how to use equipment properly
- Follow any operating instructions that are provided
- Watch out for worn paddle gear
- Use the right size hole in your windlass and use the safety catch on the paddle gear
- Only use a boat-hook or pole when the boat's still
- Keep fingers clear of ropes – sudden tension in the rope can trap fingers
- Don't wrap ropes around any part of your body
- Don't use ropes to stop the boat – use the engine
- Don't push off from the side of another boat with your pole. It could slip on the smooth surface



True stories

Tools that bite back

Take a lesson from this hire boat crew, coming across their first lock. Jane left the windlass on the spindle and then let go. The ratchet slipped and spun the handle round, breaking her nose and teeth.

Rope tricks

Crushed fingers and rope burns were the painful end to a holiday for Robert. While holding the mooring rope around a bollard, a sudden tug from the boat pulled the rope – and his fingers – into the bollard. His fingers were trapped until the skipper brought the boat further in and the rope slackened off.

Lock safety

Though boating accidents are few and far between, many of them happen in locks.

Moving through a lock is perhaps the trickiest part of boating. There's a lot to think about at once and a whole series of tasks to carry out.

Practically all the safety tips we've come across so far apply here. But you also need to be extra alert. If your boat gets caught up, it could come crashing down into the lock. Should there be a fire on your boat it is harder to escape, and it could spread quickly to other boats sharing the lock.

There's more guidance on how to use locks on pages 16 to 29.

What causes accidents in locks?

- Lack of knowledge or preparation
- Not paying attention
- Rushing the procedures

Safety essentials

- Make sure the boat's level and free. It should be away from the cill, not caught on a gate or projection and the ropes should be able to run freely
- Open the paddles (sluices) gradually
- Make sure that each member of the crew sticks to their allotted task – accidents happen when crew wander off, especially with a big crew
- Adult crew must be in charge of the lock
- Watch out for 'helpful' bystanders – their mistakes could land you in trouble
- Have a steerer at the helm all the time when the boat is in a lock



True stories

Stay alert – stay afloat

They were experienced hirers, well-used to using locks, but while the crew opened the paddles to let out the water, the helmsman went inside the boat to put the kettle on.

The back of the boat caught on the cill while the front of the boat continued to float down – the crew

didn't notice until it was too late. As the water level dropped, the boat crashed down, flooded and sank. Though badly shocked, the helmsman wasn't injured. The canal, though, had to be closed and a crane hired to raise the boat.

Fast-flowing water

Most canals are calm and smooth-flowing, but rivers can catch you out with strong streams, currents or, in some cases, tides. Handling a boat in fast-flowing water takes special skill and good judgement. What's more, the usual risks are magnified – a current makes collisions more likely, for example, and makes it harder to recover a person overboard.

What causes accidents?

- Inexperience
- Taking on too much of a challenge
- Not communicating properly

Safety essentials

- Boating with an experienced skipper is the best way to gain experience
- Get an update on river conditions before setting off
- Make sure your boat has enough power to cope with the strength of the stream or tide
- Have a good anchor and chain ready for use. Preferably have two anchors rigged and ready for use, one at bow and one at stern
- Steer clear of weirs
- Look out for big commercial boats and prepare to give way

Make sure you're prepared – get information on unfamiliar waterways, take advice and obey warning signs.

See the contacts on page 64 for how to get the current river conditions.

Tidal waters

A minimum crew of two, the use of VHF marine-band radio and the wearing of a life jacket is recommended when travelling on tidal waters. Skippers should also check tide times, weather forecast and other local conditions before planning passage. It is also important to check local radio channels when planning passage.

Freight waterways

Be prepared for higher than normal wash on freight waterways. Always ensure your vessel is moored securely on freight waterways.

It is important to choose your mooring spot carefully on freight waterways avoiding tight turns, blind spots and narrow sections of waterway.

Freight skippers will often announce their position to lock keepers and other skippers by VHF Marine Band Radio, use of Marine Band Radio is recommended on freight waterways. Local waterway offices can also provide details of freight vessel movements if required.

Large freight vessels especially when loaded may not always be able to move far from the centre channel. Always give freight craft additional room when passing. It may not always be possible to pass port to port when passing freight vessels.

Skippers of all craft should familiarize themselves with the sound signals especially if they do not have a VHF marine band radio.

Strong stream conditions

Warning

Don't cruise in strong stream conditions – tie up securely, watch for changes in water level and adjust your mooring ropes as necessary.

Strong stream warnings

The Environment Agency gives out stream warnings to tell you about conditions that may mean you shouldn't go out in your boat. **See page 64 for how to get information.** You may also see red flags or warning boards at boat clubs, marinas and locks.

Strong stream advice on the River Thames

Look out for warning boards on lock gates.

**CAUTION
STRONG
STREAM**

Users of all boats are advised not to navigate because the strong flows make it difficult and dangerous.

**CAUTION
STREAM
INCREASING**

Users of all unpowered boats are advised not to navigate and users of powered boats to find a safe mooring. This is because river flows are likely to strengthen, and red boards could be displayed very soon and without further warning.

**CAUTION
STREAM
DECREASING**

Users of all unpowered boats are advised not to navigate and users of powered boats to navigate with caution.

Strong stream advice on the River Medway

Look out for warning boards on lock gates.



Strong stream conditions

River Advice for Boaters (RAB) on the Anglian Waterways

The Environment Agency issues River Advice for Boaters on the River Ancholme, River Nene and River Great Ouse (between Bedford and Earith) to inform river users when river conditions are changing and when locks are being prepared or used to discharge flood water.

Look out for notice boards and lights that are displayed prominently on riverbanks to inform boaters of the status of the river. Flags are also raised at several boat clubs, marinas and some locks.

Boaters are strongly advised not to navigate when the Strong Stream Advice message is in force when some locks may be 'reversed' for flood control. **For an explanation of reversed locks see page 27.**

Boaters are encouraged to sign up and receive free River Advice for Boaters messages when using the River Thames and Anglian Waterways. **For details on how to sign up for this free advice see page 64.**

Strong stream advice on Canal & River Trust waterways

Check on the Canal & River Trust website for strong stream warnings.

www.canalrivertrust.org.uk/stream

Don't cruise in strong stream conditions – tie up securely, watch for changes in water level and adjust your mooring ropes as necessary.



Navigation Warning System

Check water level on indicator board before proceeding

- Do not proceed**
Hazardous conditions exist
- Proceed with caution** – Navigation conditions liable to change
- Navigation conditions normal

The indicator board is located on the lock wing wall on the river side of the bottom lock gate

Strong stream warnings website

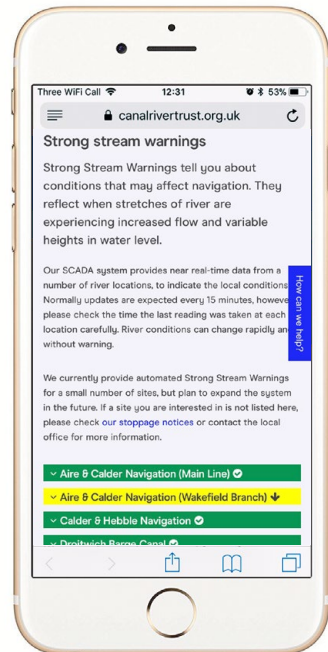



Special safety tips

- Please moor up safely if you see strong stream warning signs or are advised by navigation staff to stop. Even the most experienced boater can be caught out, so think about those who could be put in danger if they have to help you
- Moor your boat in a safe place, preferably in a marina or at a recognised mooring. Limited space may be available at some locks. Moor against high banks if you can
- Ensure your mooring lines are fastened to secure fixings such as bollards, rings or even trees; put out extra lines for additional security and allow enough slack for a further rise in river levels; don't rely on your own mooring pins or stakes – they might not hold
- If necessary, put extra fendering (eg scaffold poles or strong timber posts) between your boat and the bank side, to prevent your boat drifting onto the river bank and becoming caught up when levels drop
- Make sure you have a safe exit ashore from your boat as the level rises. If not, you should consider returning home or finding alternative accommodation until conditions improve
- If you are running low on essential supplies and are not able to leave your boat call 101 and seek advice or assistance
- If you have a serious safety concerns and are not able to leave your boat safely, treat this as an emergency and dial 999 to ask for evacuation
- For hire boaters: if you are advised to stop, you must do so then call your boatyard and follow their instructions



True stories

Ignoring warning leads to tragedy

There'd been several days of heavy rain and the river level was rising, but this boater – out in his own fibreglass cruiser with his girlfriend – ignored the strong stream warning

signs. He left it too late to moor up and his boat was swept sideways down the river. As it wedged against a bridge, his girlfriend fell overboard and was swept away.

Vandalism and aggression

There's little that's more peaceful than cruising a stretch of quiet waterway. But in a very few urban areas, things aren't as laid-back as they should be. Keep an eye out for trouble-makers. The main problems to watch for are missiles being thrown or dropped, youths jumping in, particularly in locks, and theft.

- Watch out for vandals dropping objects when you go under bridges, through locks and at tunnel entrances and exits
- Keep a low profile and avoid confrontation
- Don't moor where there could be a risk
- Know your location in case you need to call for help
- Have a camera and a mobile phone to hand
- Keep valuables out of sight

If things get difficult

- Call the police. Dial 999 if you are in immediate danger. Or 101 to report suspicious behaviour. Know your location before calling. Ask the police to give you an incident number
- Keep a safe distance away if you can
- Stay calm. Don't antagonise the aggressors
- Speak clearly and firmly. Don't raise your voice or argue
- Maintain eye contact
- Be understanding and avoid arguments

Report any damage to locks and other navigation structures to the navigation authority. **See contacts on page 64.**

Waterborne diseases

Waterborne diseases, including Weil's Disease (leptospirosis), are extremely rare, but it's sensible to take a few precautions.

- If you've got any cuts or scratches, keep them covered
- If you fall in, take a shower and treat cuts with antiseptic and a sterile dressing
- Wash wet clothing before you wear it again
- If you develop flu-like symptoms within two weeks, see your doctor and mention that you fell in the water. Not all doctors will know to look for signs of Weil's Disease, so do suggest it as a possibility
- Clean hands before handling foodstuffs. (Antibacterial hand gel can be used.)
- Please only use hosepipes for temporary filling of on-board tanks – please disconnect the hosepipe from the tap when not in use. Permanent or long term connections must be properly plumbed in rather than using hosepipes
- As hosepipes are deemed by water supply regulations to be "semipermeable" and so at risk from potential contamination, please ensure your hosepipe does not trail in the canal or other standing water

Training and guidance

Boat-handling training courses

Consider taking a professionally run course in boat and unpowered craft handling, particularly if you are planning to boat regularly. The knowledge you gain will make your boating safer and more enjoyable.

The Royal Yachting Association

(RYA) Inland Waterways Helmsman's Certificate is highly regarded. It is not compulsory in this country but is required on some waterways abroad. You can go on a two day course to qualify. Get details on the RYA website: www.rya.org.uk/go/inlandwaterways or call the RYA training section on 023 8060 4181.

The **RYA Inland Waterways Handbook** (written to accompany the course) is an excellent well-illustrated book available to buy from the RYA online shop: www.rya.org.uk/shop

NCBA community boats

Run a number of courses. See www.national-cba.co.uk, call 0845 0510649 or email staff@national-cba.co.uk for details.

British Canoeing

See www.britishcanoeing.org.uk or call 0300 0119 500. Courses for fundamental and more advanced skills are available

Boater's Handbook DVD

The Canal & River Trust and Drifters, the UK's biggest consortium of hire boat companies, have teamed up to make a DVD covering boating basics. It is a companion to this handbook, with lots of tips for first-time hire boaters and new boat owners. We hope it will also be a reminder for more experienced boaters – with important information about how to boat safely.

You can view the twenty five minute film at www.canalrivertrust.org.uk/safeboating. Or if you would like it on DVD, call customer services on **0303 040 4040**.

Boat Safety Scheme



Boat Safety Scheme: mandatory on most inland waterways, minimum safety requirements addressing fire, carbon monoxide poisoning and pollution prevention, four yearly MOT-style examinations and the promotion of essential safety advice and tips that will help keep boaters safe.

0333 202 1000 or go to www.boatsafetyscheme.org

Carbon Monoxide

Each year boaters die or are made seriously ill from carbon monoxide (CO) poisoning – Boats are built to keep water out, but this also makes them good containers for gases and fumes.

When carbon-based, appliance and engine fuels, such as gas, LPG, coal, wood, paraffin, oil, petrol and diesel don't burn completely, CO is produced.

CO build-up in the cabin can occur with one or a mix of these factors:

- With faulty, badly maintained, or misused appliances
- Exhaust fumes from a boat's engine or generator
- Escaped flue gases from solid fuel stoves
- Short supply of air – fuels need the right amount of oxygen to burn safely

10 tips to keep you and your crew alive!

- Install a certified CO alarm (BS EN 50291-2), test it routinely and never remove the batteries
- All the crew should know the symptoms of CO poisoning and how to react if it is suspected
- Install fuel burning appliances properly, in-line with makers directions
- Follow servicing guidelines; maintenance should be routine and competent – Don't allow bodged repairs, adjustments and adaptations
- Always use appliances as per the instructions and never use cookers for space heating
- Don't block ventilation – appliance fuels like gas, coal, wood, oil, paraffin, etc. need sufficient air to burn safely
- Don't bring charcoal BBQs on board, or have them near a cabin during or after use – only stone-cold charcoal is safe
- Keep engine fumes out of the cabin space, never use a portable generator in or near a cabin
- Learn about the danger signs, spot potential hazards before CO occurs
- Deal with problems immediately, never use equipment you suspect has problems

For more advice on carbon monoxide poisoning visit the Boat Safety Scheme website [**www.boatsafetyscheme.org/stay-safe/carbon-monoxide-\(co\)**](http://www.boatsafetyscheme.org/stay-safe/carbon-monoxide-(co))

Unpowered craft

Exploring canals and rivers by canoe, kayak or Stand Up Paddle Board (SUPB) can help you get fit, closer to nature and allows you to experience waterways from a totally new angle.

- Stay safe when canoeing, kayaking or using small unpowered craft
- Make sure your craft is suitable for the waterway you are using and that you are competent to use it
- Check the stream conditions, weather forecast and navigation notices before you set out
- Wear or take appropriate waterproof clothing which can include additional dry clothing and layered items which can easily be removed. It is advisable to take refreshments and a mobile phone
- Novices should always be accompanied by an accomplished canoeist, SUPB user or boater
- Larger craft need deeper water and room to manoeuvre. The standard practice is to follow the navigation rules and keep to the right-hand side of the channel in a position for the helmsman to see you
- When meeting a powered craft on a canal or narrow channel communicate with the helmsman to indicate your intentions and these are acknowledged. A group shall avoid dispersing either side of an oncoming powered craft
- Keeping a proper lookout is very important for safe navigation and give way as required to on water events
- If there is risk of collision the conventional Shouted Warning calls for paddlers and rowers are:
 - **‘Take a Look’** (other boat) potential risk of collision,
 - **‘Ahead’** (other boat) imminent risk of collision,
 - **‘Hold it up’** precautionary stop,
 - **‘Hold it hard’** Emergency stop
- You are strongly advised to wear a personal flotation device with attached whistle, and be water confident
- Locks, weirs and sluices require great care. On Canal & River Trust waters unless authorised, don't stay on board your craft in a filling or emptying lock – carry it around or if it's too heavy, use lines to keep control
- The Canal & River Trust permit canoes and kayaks with crew on board to use locks on the Rivers Severn & Trent and at Carpenters Road & City Mill Locks to access Bow Backwaters
- Group organisers should ensure that the number of craft in the group are in keeping with the nature of the waterway. For the safety of the group and other waterway users you should not impede other boat movements

Stand Up Paddle Boards (SUPBs)

Warning

Wind – unpowered craft including Stand Up Paddle Boards and inflatable boats are vulnerable to the effect of the wind that can have a significant effect on safe handling especially on exposed sections of waterway such as on embankments and aqueducts. Follow local instructions where SUPBs and inflatable boats are not permitted, for example on exposed aqueducts.

Stand Up Paddle Board in locks – why not?

Lock operation causes turbulence inside the lock chamber. Boats are required to be secured and controlled by two lines, whilst occupants of small craft (e.g. canoes) must hold onto the grab chains where fitted or controlled by a free running line around a bollard or other fixing. It is not safe for SUPBs to do this – balancing on a board has more risk than being contained inside a boat.

In order to reduce the risk to SUPBs, lock operation would need to be carried out much more slowly to keep water movement to a minimum. This will cause delays to other traffic, allowing queues to build up and hinder efficient river traffic movement at peak times.

Many locks can accommodate a large number of boats of all shapes and sizes, including large commercial boats (e.g. passenger boats). There is no safe place for a SUPB to be inside a lock chamber in these circumstances, but locking through a single SUPB will cause delays and waste water.

A SUPB in a crowded lock chamber will also mean other boats need to manoeuvre more carefully in order not to put the SUPB at risk of collision or capsise.

At locks with no assisted passage (i.e. no staff on duty), risks are enhanced. Where locks are operated by the public, emergency procedures may be slower. It is not appropriate to expose boaters operating the lock to the unnecessary risks presented by SUPBs sharing the lock chamber.

It is much quicker, safer and more efficient for a SUPB to portage – there is no valid reason to lock through other than to chalk up the experience!

For more information visit www.britishcanoeing.org.uk/stand-up-paddleboarding-sup

Channel markers

If there's a channel you should stick to it – it'll usually be marked by buoys or by red cans and green cones. If you're heading downstream, keep the red cans to your right and the green cones to your left. If you're going upstream, the red markers should be on your left and the green on your right.

Weirs

Straying out of the channel can be very dangerous – especially if you find yourself near a weir. Do not pass close to any weir, keep well away

Watch out for the warning signs.



Giving way

If you're approaching a bridge or narrow section, slow down. If a boat coming in the opposite direction is closer to the bridge, wave them through and keep right until they're well clear. **On rivers, the boat coming downstream has right of way.**

Overtaking

You will rarely need to overtake on canals and narrow rivers. There isn't usually enough space to overtake safely. So just keep your distance and stay behind.

If another boat wants you to overtake, the skipper should slow down and tell you on which side to overtake – usually the left. If you're the one overtaking, it's your responsibility to stay clear of the other boat. Both skippers should go as slowly as possible to avoid the two boats being drawn together.

Speed limits

The maximum speed on narrow canals is 4mph. On rivers and broad canals limits vary, so check local information before you set out and watch out for speed limit signs on the waterway. **The non-tidal River Thames has a limit of 8kmh (5mph). On the River Medway it's 5 knots (about 5.75mph).**

Slow down approaching bridges, locks, bends or junctions, and when passing boats or anglers. River currents will speed up or slow down your boat. **Whatever the limit if you make waves you're going too fast – slow down.**

Speed checks are carried out on some waterways and there are heavy penalties including fines and prosecution that can result in a criminal record.

Passing dredgers or works

Pass on the side that's showing the green or white light or shape – not the side showing red. On canals, though, you may see both sides marked with red during the day – follow the instructions given by the works crew.

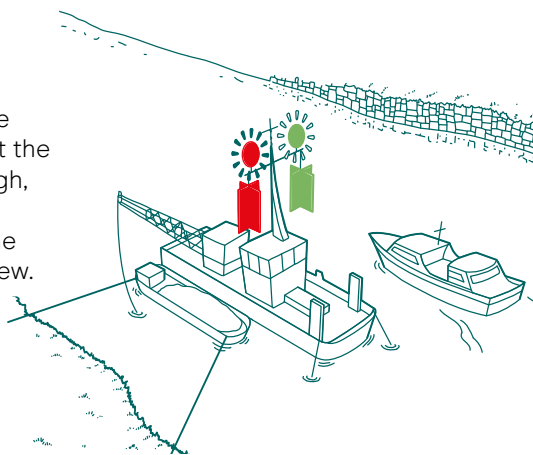

Sound signals

1 blast = going to the right

2 blasts = going to the left

3 blasts = I'm trying to stop or go backwards

4 blasts – pause – 1 blast = turning round to the right

4 blasts – pause – 2 blasts = turning round to the left

1 extra long blast = warning at tunnels, blind bends and junctions

Navigation lights

It's best not to cruise in the dark. If you do, you must get information from the navigation authority in charge of your waterway. The rules governing navigation lights are quite complex. As a guide, at night and in poor visibility, boats usually show:

- **White lights** – front and back
- **Green light** – right side
- **Red light** – left side

As a result, if you see:

- A white light above a red one, it's likely to be a boat crossing from your right to the left side
- White above green is likely to be a boat crossing left to right
- White above green and red means the boat is coming towards you

Alternatively unpowered craft must show a single white light visible through 360deg.



Warning

Cruising at night can be dangerous.

Moor up before it gets dark and avoid using locks at night.
Cruising after dark is not permitted by hire boat companies.

Water sport zones

In some areas of the Canal & River Trust network 'water sport zones' have been established with signage at the entry/exit points to highlight that these areas can be busy with unpowered craft.

Please take extra care in these zones as serious injury and/or damage will result from a collision.

These simple precautions will ensure the waterway network can be shared safely by all craft.



Special safety tips

Being safe around rowers, paddlers and other unpowered craft.

In the watersport zones and other areas of the waterways popular with rowers, canoeists, kayaks, paddle boards and other unpowered craft it is essential to follow the guidance below if we are to ensure the safety of unpowered and powered craft alike,

- Keep a careful look out – many unpowered craft such as rowing racing boats are low in the water and can be hard to see. Please keep a sharp look out, particularly on bends and in poor visibility. Remember that rowers and canoeists train at all times of day and even after dark (craft should have lights when in use after dark or where permitted in tunnels)
- Navigate slowly and to avoid excessive wash and keep to the right when passing oncoming unpowered craft
- Display appropriate lights at night without dazzling
- Sound a horn at bends and when you see unpowered craft to alert them to your approach.

See page 58 for Sound signals

- Observe 'no mooring' and other mooring restrictions such as on bends and in busy areas; **these are in place to ensure that navigation remains clear and safe for all craft**
- In some places mooring is restricted to single width boats with no double mooring; please abide by these restrictions. Rowing boat oars can be up to 4m long, meaning a rowing racing boat can have a width of around 7m. Mooring restrictions are in place to ensure that powered and unpowered craft can pass safely and avoid collisions

Caring for the environment

Please help to keep the waterways pleasant places for everyone who uses them – and for the wildlife that depends on them.

Follow the Green Guide to Inland Boating

The Green Blue, a joint venture by the British Marine and the Royal Yachting Association, provides practical advice and information on how to maintain, equip and operate your boat in an environmentally friendly manner.

Follow the link on page 68 to read the full guide and the British Canoeing leaflet *You, your canoe and the environment*.

Manage your waste

Don't pump oily water from your bilge into the waterway. Use an oil-absorbent sock or similar around the pump intake. Well-maintained engines shouldn't leak oil. Check the drip tray under the engine and gearbox regularly. If it starts getting oily, find and mend the leak. Ideally use biodegradable oils.

Avoid spilling petrol and diesel. If you do, mop it up – don't use detergents.

The toilets on your boat mustn't discharge sewage into the waterway. There are pump-out facilities for chemical or closed toilet systems at marinas and sanitary stations (check navigation guides or authority's websites for details of locations). Use the minimum amount of chemicals to avoid upsetting the sewage treatment

system. If you have a closed toilet system, you may not need to use chemicals at all – so check your manual. Composting toilets are intended to do just that – make compost. If that's not what you are using the waste for or if you can't keep it stored until it's ready to use, it will still need to be disposed at an Elsan/sanitary station (www.canalrivertrust.org.uk/water-and-elsans) – if not properly composted it may still contain dangerous bacteria such as E Coli. Liquids go into the Elsan unit and solids should be bagged in a nappy bag and placed in the domestic waste bins (www.canalrivertrust.org.uk/rubbishblog). Please don't dump liquid and solid waste on the towpath or into the water, knowing that it hasn't composted properly.

It is permissible for the wastewater from sinks, showers, washing machines and dishwashers to flow straight into the waterway. However, normal detergents and cleaning products contain chemicals that can be harmful to fish and sensitive aquatic life. So to help keep the water as healthy as possible, put your cooking waste in the bin, and use environmentally-friendly detergents.

Please don't throw any waste overboard – even apple cores take a long time to rot. Litter can kill wildlife, and it can cause problems for other boaters by getting tangled in their propellers. There are plenty of waste disposal points at marinas and along the waterway. Although recycling points are not universal at waste disposal points there are also plenty of public sites near waterways and you can find them through www.recycle-more.co.uk/bank-locator

Protect wildlife

When you go too fast, your wave can damage banks and sensitive plants. If you see your wash hitting the bank, please slow down. Cut your speed and keep your distance when passing nesting water birds too. Wildlife will usually move out of the way as you pass, but please try and avoid disturbing wildlife, keep your distance and try not to harm them.

The side of the channel opposite the towpath is often especially rich in wildlife, so take special care not to disturb plants or animals there. Don't moor on this side unless there are proper mooring facilities. Try and limit any damage to vegetation on the towpath side, we try to manage our vegetation so there is safe access along the towpath and off boats, but we do leave areas for wildlife as well.

Invasive Alien Species & Bio-security

Invasive (alien) species are a major threat to our native wildlife, but also cause damage to our waterways. Many thrive in our waterways and are spread on boat hulls and propellers, in bilges or engine cooling systems. Avoid spreading invasive species by following the **Check, Clean, Dry** code. Check your boat or unpowered craft for living animals and for bits of plant where water can pool on deck, in cavities or where vegetation can catch like fenders, props, rudders and anchors. If you do come across any

organisms, leave them in a bin at the water body where you found them. Clean all equipment, footwear and clothes thoroughly, then dry it for as long as possible. Some species can live for many days in moist conditions. Try to keep areas on your boat clean, clear regularly where water can pool, or vegetation can collect.

Download the Check, Clean Dry code at www.nonnativespecies.org/checkcleandry

Follow the Countryside Code

Respect other people

- Consider the local community and other people enjoying the outdoors
- Leave gates and property as you find them and follow paths unless wider access is available

Protect the natural environment

- Leave no trace of your visit and take your litter home
- Keep dogs under effective control

Enjoy the outdoors

- Plan ahead and be prepared
- Follow advice and local signs

There is a link to the full Countryside Code on page 68.

If you encounter wildlife or animals in distress contact the RSPCA telephone call 0990 55 59 99 (24 hours).

What makes a good boater?

Everyone deserves a place to escape. To help you get yours, fellow boaters have come up with the following guidelines:

- Go slow before, and during, passing moored boats
- Only run your engine or generator between 8am and 8pm and be neighbourly and considerate
- Revving engines, running generators, unnecessary use of the horn, loud music and shouting – can all be a real nuisance to other people and wildlife, please try and avoid these
- Don't run the boat engine in gear when you are moored – it can damage the waterway wall or bank and disturb adjoining boats
- On mooring up at busy spots check you haven't left a big gap and don't overstay
- Don't block the towpath or put your mooring stakes or ropes where people could trip over them
- Don't moor opposite winding holes, on bends, or near to bridges
- Don't hold an event on the waterways without contacting the local waterway team to make the required arrangements
- Bag it and bin it (especially your dog's waste) – never fly tip on the towpath
- Only stay on a water point or a lock landing when you're filling up or locking through
- Ask to share locks (and the work) and don't jump in front, especially if another boat is waiting or the lock is set against you
- Take time to check all paddles and gates are shut after you've used a lock
- Ease over if others want to overtake
- Keep to the centre of the channel when passing anglers – unless they ask otherwise. Reduce your wash, but keep a steady pace
- Respect the natural and built fabric of the waterways
- Report any pollution or fly-tipping to the Environment Agency incident hotline on **0800 80 70 60** 24 hours

Please use waterway waste facilities responsibly

Don't over-fill bins or abandon waste on the floor outside bins/skips or put general waste in recycling bins where these are provided. Misuse of bins is unpleasant for other users and neighbours; can attract pests and vermin; and increases operating costs which could lead to increased boat licence fees or reduce services. If a waste site is full or there is some other problem, please contact the operator and take your waste to another site.

Contacts



**Environment
Agency**

The Environment Agency is responsible for the River Thames, Anglian waterways and the River Medway.

For boating information call **03708 506506**

or go to **www.gov.uk/environmental-management/boating**

To report an incident call **0800 80 70 60** 24 hours

To check river conditions call **0345 988 1188** 24 hours.

Choose option 1 then enter the relevant quick dial extension:

Anglian waterways:

- 032112** River Nene
- 033211** Great Ouse – Bedford to St Ives
- 033212** Great Ouse – St Ives to Earith
- 031212** Ancholme

River Thames:

- 415000** Upstream of St John's Lock to Radcot Lock
- 415001** Rushey to Godstow Lock
- 415002** Osney to Iffley Lock
- 415003** Sandford to Clifton Lock
- 415004** Day's to Mapledurham Lock
- 415005** Caversham to Shiplake Lock
- 415006** Marsh to Boveney Lock
- 415007** Romney to Bell Weir Lock
- 415008** Penton Hook to Chertsey Lock
- 415009** Shepperton to Teddington Lock
- 415010** River Kennet upstream of Blake's Lock

or go to **www.gov.uk/check-river-conditions-and-closures**

 Sign up to be sent free River Advice for Boaters messages for Anglian Waterways call **020302 55068**, office hours, or email **WaterwaysSSAAnglian@environment-agency.gov.uk**

You will need to provide the following information: Your full name and address. A telephone number for a voice message, once we have this you can choose to also receive text and/or email messages. Which river(s) you would like to receive the messages for (Great Ouse, Nene, Ancholme). A security question password – we usually use your boat name or registration number if you have one

River Medway:

012644 River conditions and strong stream warnings.

To sign up to strong stream advice on the Upper Medway boaters need to contact Allington Lock on **01622 752864**, or email **allington.lock@environment-agency.gov.uk**

The Cam Conservancy is responsible for navigation on the River Cam in Cambridge between Byron's Pool and Bottisham Lock.

For boating information call **01223 863785** or go to **www.camconservancy.org**

The Avon Navigation Trust is responsible for navigation on the Warwickshire Avon between Tewkesbury and Stratford-upon-Avon.

For boating information call **01386 552517**, email **office@avonnavigationtrust.org** or go to **www.avonnavigationtrust.org**

The National Trust is responsible for navigation on the River Wey and Godalming Navigations between Godalming and Weybridge on the River Thames.

For boating information call **01483 561389** or go to **www.nationaltrust.org.uk/river-wey-and-godalming-navigations-and-dapdune-wharf**

The Port of London Authority is responsible for the tidal River Thames from Teddington.

For boating information call **01474 562200** or go to **www.pla.co.uk** and click on *Leisure*

The Middle Level Commissioners are the navigation authority for the navigable waters of the Middle Level system.

For boating information visit **www.middlelevel.gov.uk**

The Bridgewater Canal is owned and operated by The Bridgewater Canal Company Limited, part of The Peel Group, in conjunction with the Bridgewater Canal Trust.

For boating information visit **www.bridgewatercanal.co.uk/boating**

Contacts



The Canal & River Trust is responsible for the majority of the other canal and river navigations in England and Wales.

The 2,000 miles of canals and rivers the Trust looks after accommodate over 35,000 boats. These boats are home, holiday and workplace to thousands of people and the Canal & River Trust is proud to support this thriving community by safeguarding the canals and rivers.

The Trust supports all boaters and holiday makers to make the most of its historic waterways, however long their stay. Life is better on and by the water and the Trust seeks to make sure as many people benefit from the waterways as possible.

For boating information go to www.canalrivertrust.org.uk/boating

To report an incident call **0303 040 4040** 8am–6pm, Mon–Fri, email customer.services@canalrivertrust.org.uk or complete a freepost form at www.canalrivertrust.org.uk/incident

In an emergency call **0800 47 999 47** 24 hours
Please **ONLY** use if the matter is genuinely urgent.

Navigation problem (e.g. broken-down lock, insufficient water in the canal, fallen tree) call **0303 040 4040** 8am–6pm, Mon–Fri. Out of hours emergencies call **0800 47 999 47**. Depending on the nature of the problem the Trust will do its best to fix it as soon as possible. We will prioritize emergencies. Please bear in mind that fewer staff are on duty out of weekday working hours.

  Sign up to get email and/or Twitter updates of stoppages and other notices [@CRTNotices](https://twitter.com/CRTNotices) and www.canalrivertrust.org.uk/boating and boaters update www.canalrivertrust.org.uk/boatersupdate

Scottish Canals is responsible for the Caledonian, Forth & Clyde, Crinan, Union and Monkland canals.

For boating information call **0141 332 6936**
or go to **www.scottishcanals.co.uk/our-canals**

In an emergency call **0800 0729900**. Calls are answered by Police Scotland

The Association of Inland Navigation Authorities can provide details for all other navigation authorities.

Call **0844 335 1650**, email **info@aina.org.uk** or go to **www.aina.org.uk**

For the emergency services and the Coastguard:

Call **999**

British Canoeing – The national governing body for paddlesport in England

Call **0300 011 9500**, email **info@britishcanoeing.org.uk**
or go to **www.britishcanoeing.org.uk**

Canoe Wales – The national governing body for paddlesport in Wales
www.canoewales.com

British Rowing – British Rowing is the governing body for the sport of rowing

Call **020 8237 6700** or go to **www.britishrowing.org**

Useful information

Hire Boat Handover



Hire boat companies displaying this logo use the handover system endorsed by British Marine that is designed to provide all the basic skills and knowledge you need before setting off on your boating holiday. Get details at www.britishmarine.co.uk/QAB

Maps and local guides

You need a good map and guide that shows locks, weirs, bridges, tunnels and the like on your route. Hire boat companies, boatyards and marinas usually stock them. The Inland Waterways Association shop has a wide range covering all inland waterways: www.waterways.org.uk/shop

An internet search using ‘**canal guides**’ or ‘**inland waterways guides**’ will also bring up a range of possibilities, including Collins Nicholsons Waterways Guides based on Ordnance Survey maps, Pearsons Canal Companions and Heron maps.

Apps and internet-based guides provide other options.

Knots for boating

The RYA publish a ‘**Pocket Guide to Boating Knots**’ as well as a full handbook, ‘**Knots, Splices & Ropework**’ available from their online shop: www.rya.org.uk/shop

You can see how to tie boating knots by searching on www.youtube.com and on internet sites like www.animatedknots.com

Caring for the environment

The Green Guide to Inland Boating: to read the full guide, go to www.thegreenblue.org.uk and look under *Leaflets & Resources*

The Countryside Code: to read the full code, go to www.naturalengland.org.uk/ourwork/enjoying/countrysidecode

You, your canoe and the environment:

To read the full advice go to: www.britishcanoeing.org.uk/gocanoeing and look under *Access & Environment*

Common signs

 Danger Overhead electric power lines	 Danger Weir	 5'0" 1.5m Depth limited	 15'0" 4.5m Width limited	 17'6" 5.25m Headroom limited	 Overhead cable
 Weir	 No entry	 1.3m 4'-6" Maximum draft	 4.5m 15'-0" Navigation channel width limit	 4.4m 14'-6" Height restriction	 6 MPH Speed limit
 Keep to port side of channel	 Keep to starboard side of channel	 Give way to Oncoming craft	 Priority over oncoming craft	 Keep to the right	 Keep to the left
 No turning	 Do not create wash	 Sound horn	 VHF 11 Call point	 8 kmh	 Cross channel to right
 No overtaking	 Do not create wash	 Sound horn	 VHF 74 Use this radio channel	 Move over or turn in the direction	
 No motorised craft	 Ferry	 No Mooring	 Beware swimmers or divers	 No motor boats	 Beware underwater obstructions
 No anchoring	 No personal water craft	 Keep boat forward of cill marker		 Caution	 Beware Strong currents
 Refuse disposal	 Chemical doset disposal unit	 Mooring often with time limit	 Winding point	 Pump out	 Tunnel

Canal & River Trust

At Canal & River Trust, we believe our waterways have the power to make a real difference to people's lives and that spending time by water makes us healthier and happier. We are the charity that cares for and brings to life 2,000 miles of canals and rivers across England & Wales. Our waterways transform places and we bring communities together to create spaces that we can all enjoy.

Environment Agency

The Environment Agency protects and improves the environment, working to create better places for people and wildlife, and supporting sustainable development. We are the navigation authority for the rivers Ancholme, Glen, Great Ouse, Lugg, Nene, Suffolk/Essex Stour, Welland, Wye, Upper Medway and Thames as well as the Black Sluice Navigation. Around 29,000 boats are registered to use our waterways.

Scottish Canals

Safeguarding our heritage. Building our Future. We're the custodians of Scotland's canals – a vital part of our nation's rich heritage, contributing to Scottish life for 250 years.

British Marine

British Marine (BM) is the trade association for the leisure, superyacht and small commercial marine industry.

British Marine Inland Boating

British Marine Inland Boating is the main trade body within BM for inland waterway businesses, representing over 140 companies offering canal and river holidays in the UK. It encourages its members to send hirers an online link to this handbook before their holiday.

Association of Inland Navigation Authorities

The Association of Inland Navigation Authorities (AINA) is the industry body in Great Britain representing authorities responsible for the management, maintenance and operation of navigable inland waterways for public benefit. AINA endorses this important initiative by its largest members.

There is a companion film to this handbook. View it at www.canalrivertrust.org.uk/safeboating Or get it on a free DVD by calling **0303 040 4040**

